



HydroGeo
 Ingegneria per l'Ambiente ed il Territorio
 Studio Tecnico Associato Ingg. G. Gazzini, T. Staiano, A. Benvenuti



Via Cardinal Latino, 20
 50126 Firenze
 Tel 055 6587050 - Fax 055 0676043
 e-mail info@studiohydrogeo.it

**COMUNE DI PONTASSIEVE
 STUDIO IDROLOGICO - IDRAULICO
 DI SUPPORTO ALLA VARIANTE DEL REGOLMANETO
 URBANISTICO DENOMINATA 3° RUC**

ELABORATI GRAFICI

COMMITTENTE:



Comune di Pontassieve
 Via Tanzini, 30 50065
 Pontassieve (FI)

PROGETTISTI:

ING. TIZIANO STAIANO

PROGETTO	LOTTO	FASE	DOC	ELABORATO	REV
L 5 4 2	0 1	S 0 6	D	0 0 1	A

REV.	DATA EMISSIONE	REDATTO	VERIFICATO	APPROVATO
A	Novembre 2016	T.Staiano	T.Staiano	T.Staiano

TAVOLA 1
Planimetria del Modello Idrologico
 Scala 1:10000

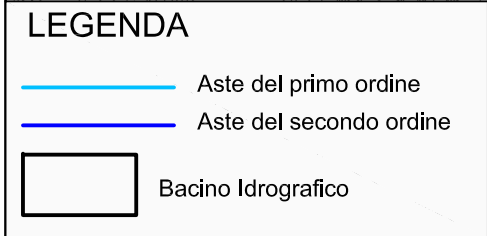
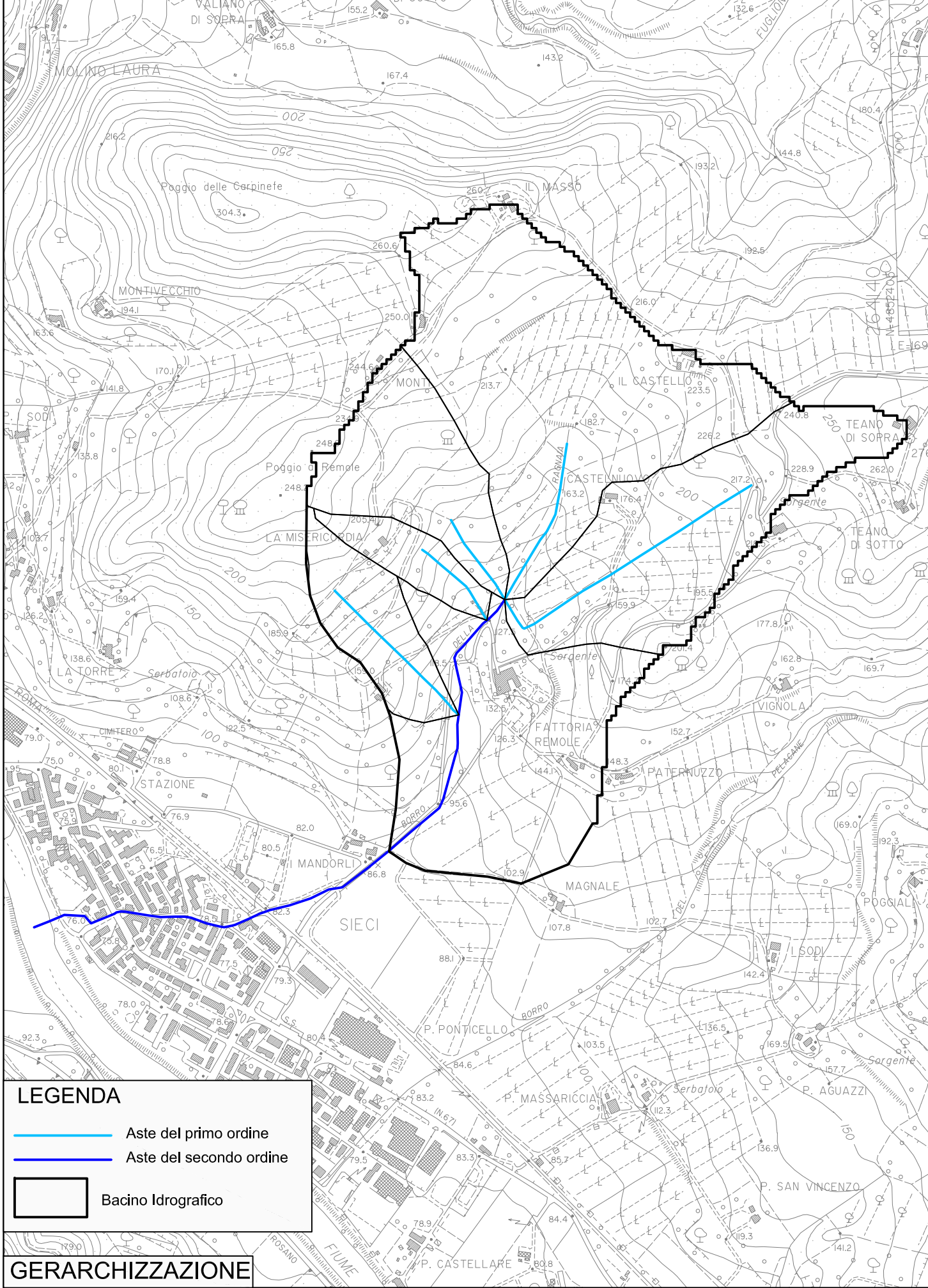

GERARCHIZZAZIONE

AREE BOSCADE

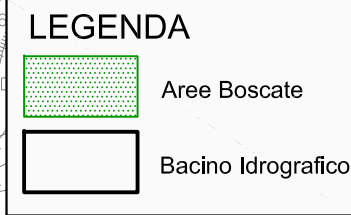
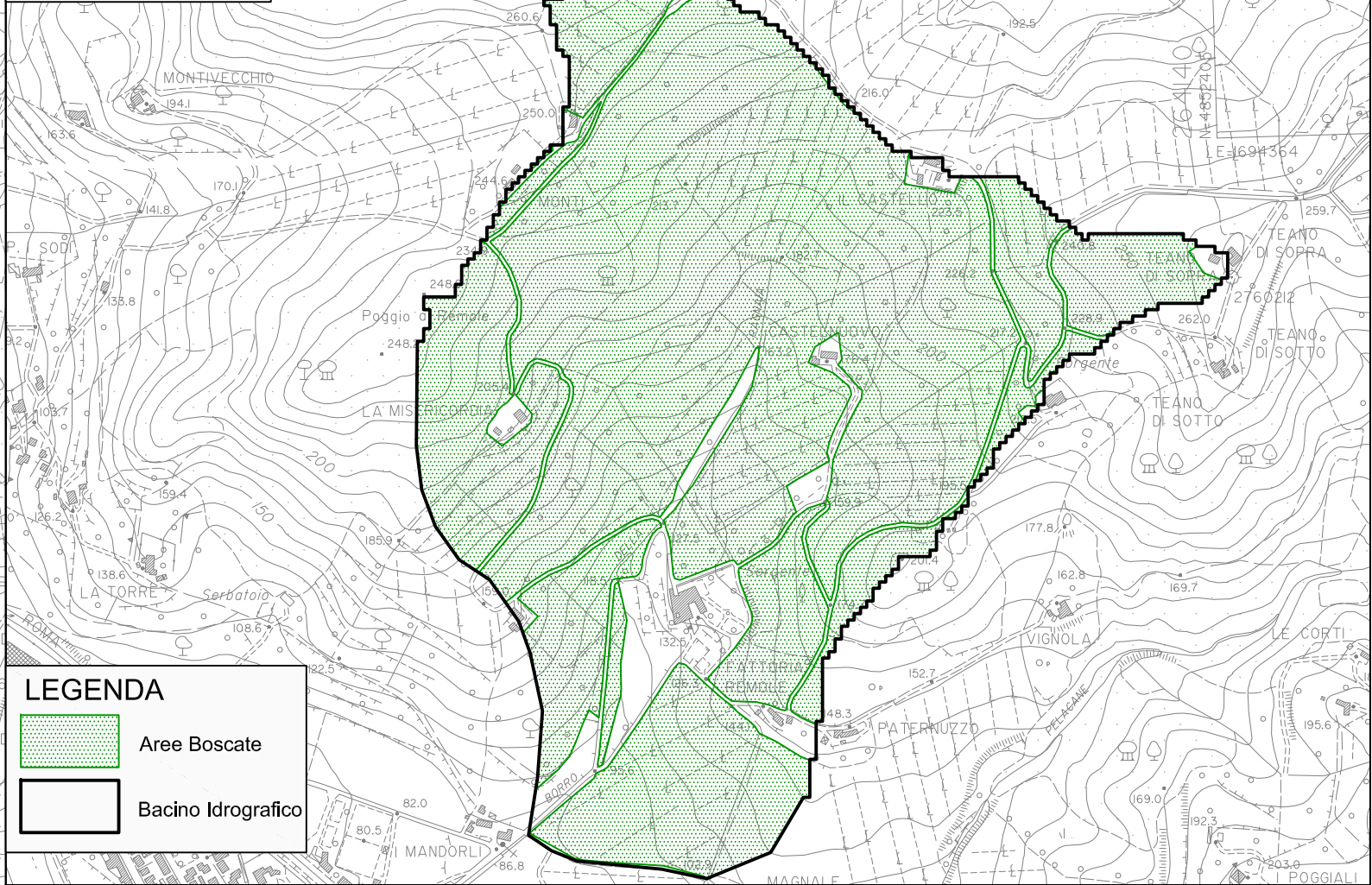

COEFFICIENTE DI INFILTRAZIONE A SATURAZIONE



TAVOLA 2A
Planimetria di Rilievo - Quadro A
Scala 1:500



Sezioni Tipologiche Tombamento - *Scala 1:50*

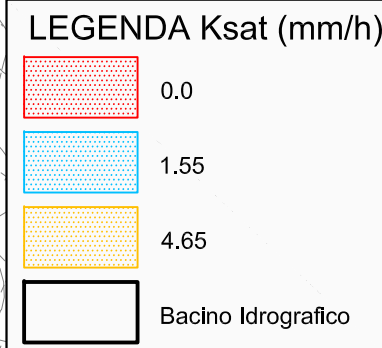
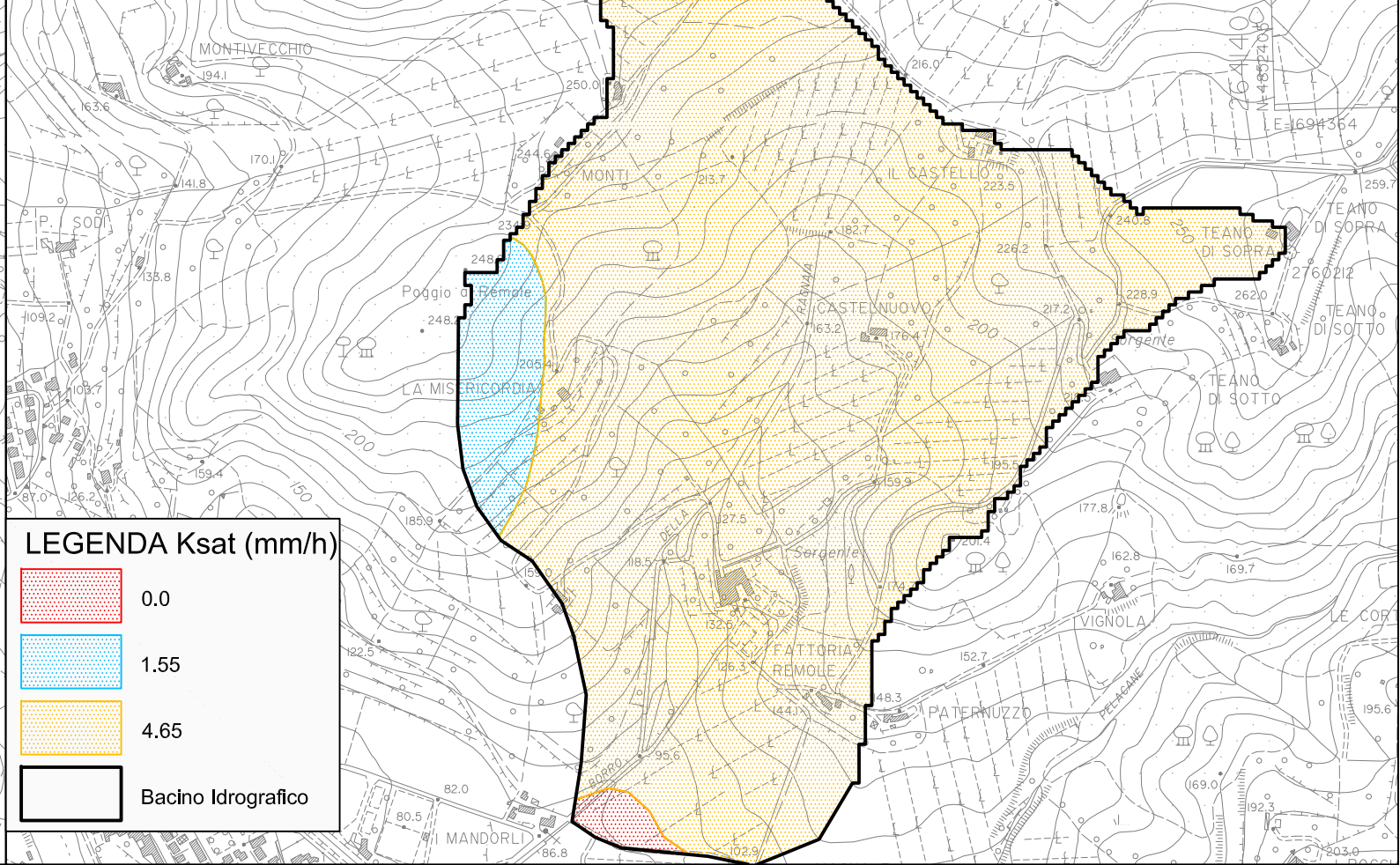
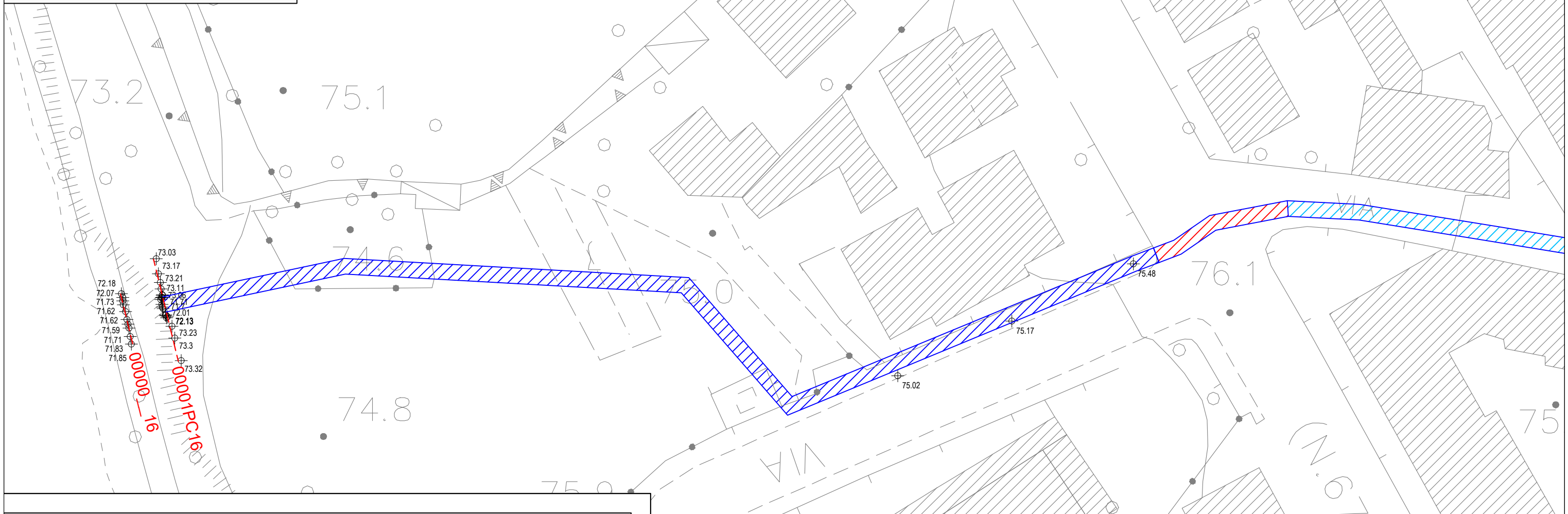
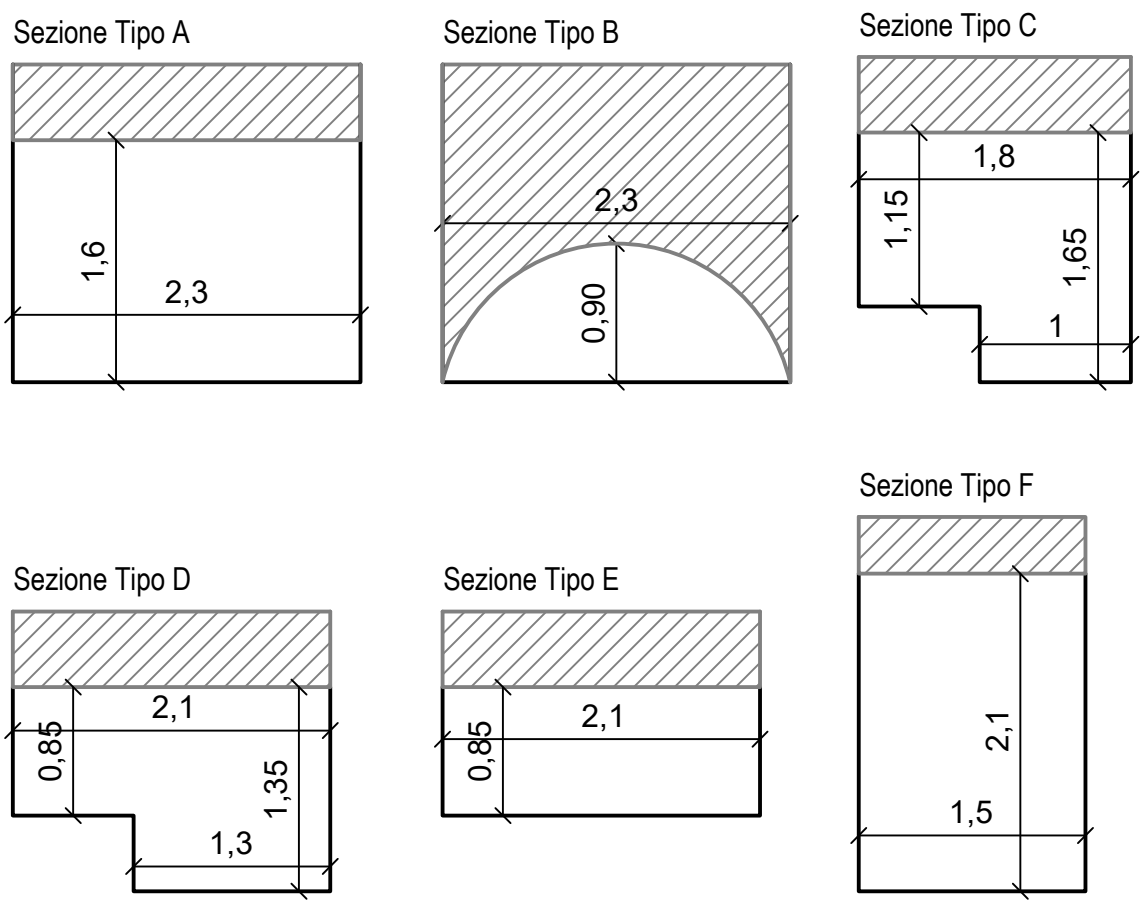

LEGENDA

- 00001PC16 Traccia Sezione Fluviale
- $\oplus_{83.93}$ Punto di Rilievo
- Tratto Tombato con Sezione Tipo A
- Tratto Tombato con Sezione Tipo B
- Tratto Tombato con Sezione Tipo C
- Tratto Tombato con Sezione Tipo D
- Tratto Tombato con Sezione Tipo E - F







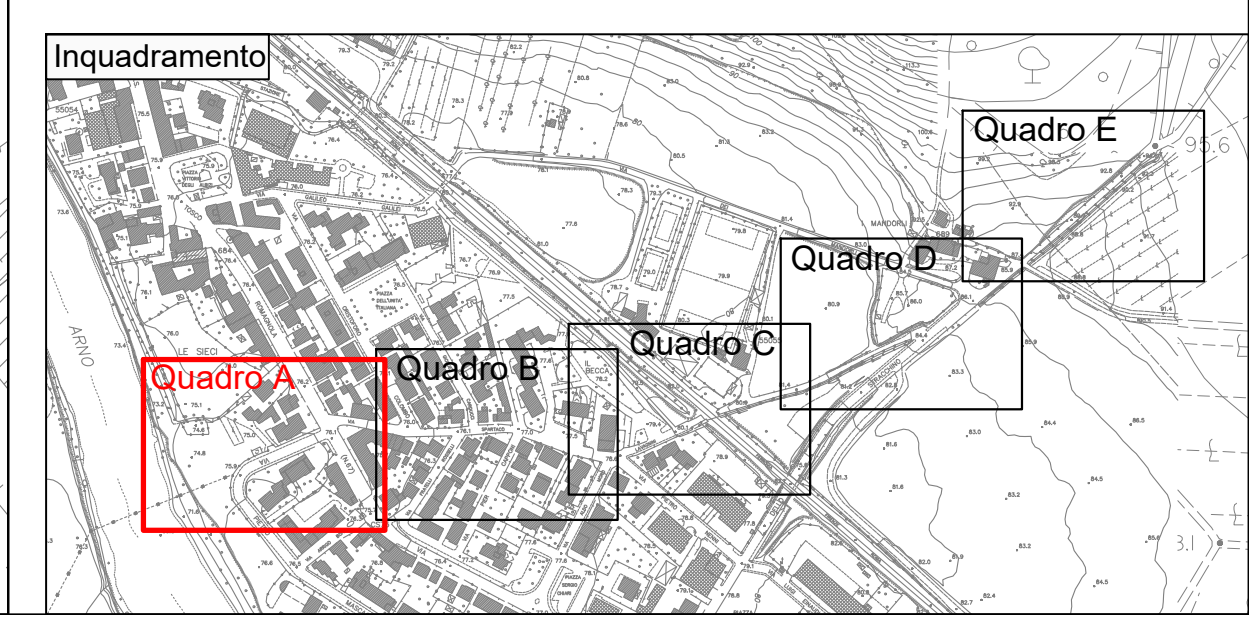

TAVOLA 2B
Planimetria di Rilievo - Quadro B
Scala 1:500

LEGENDA

- 00001PC16 Traccia Sezione Fluviale
-  Punto di Rilievo
-  Tratto Tombato con Sezione Tipo A
-  Tratto Tombato con Sezione Tipo B
-  Tratto Tombato con Sezione Tipo C
-  Tratto Tombato con Sezione Tipo D
-  Tratto Tombato con Sezione Tipo E - F



Sezioni Tipologiche Tombamento - *Scala 1:50*

Sezione Tipo A

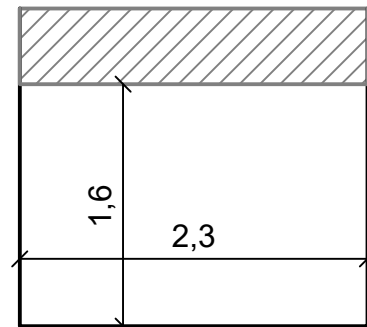

Sezione Tipo B

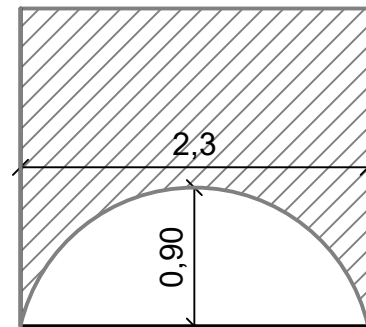

Sezione Tipo C

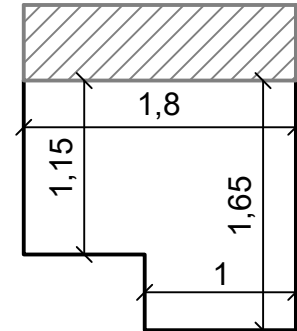

Sezione Tipo D

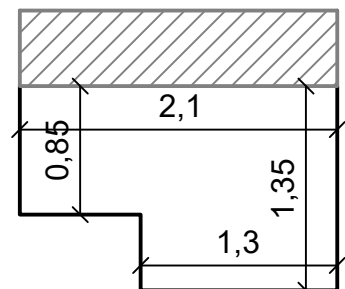

Sezione Tipo E

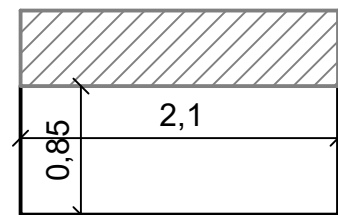

Sezione Tipo F

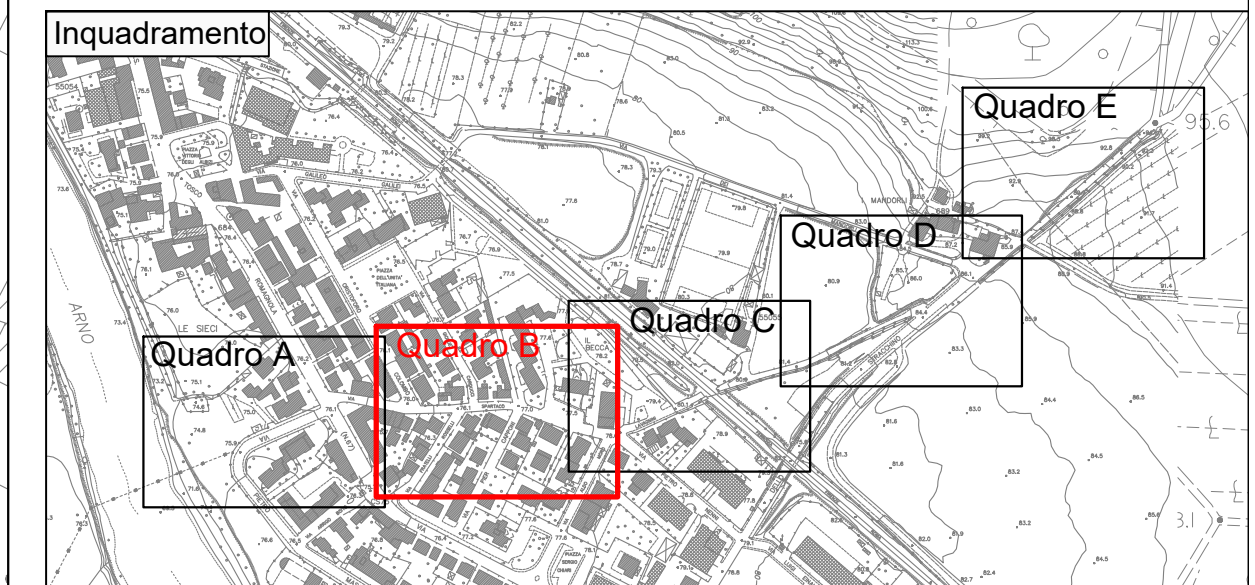
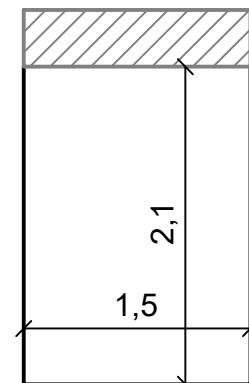

Sezioni Tipologiche Tombamento - Scala 1:50

Sezione Tipo A

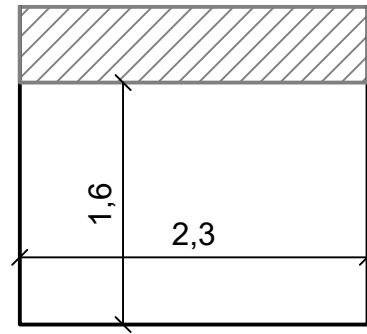

Sezione Tipo B

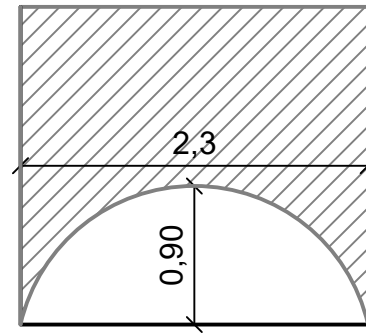

Sezione Tipo C

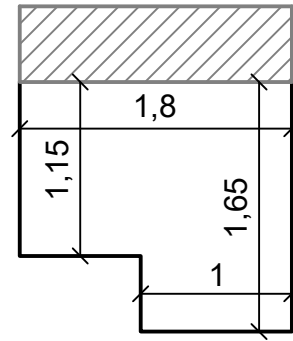

Sezione Tipo D

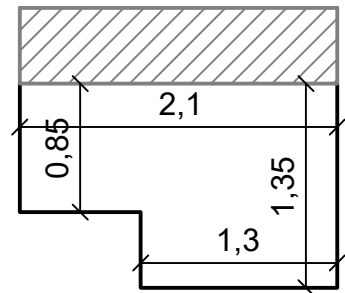

Sezione Tipo E

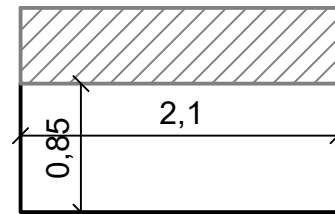

Sezione Tipo F

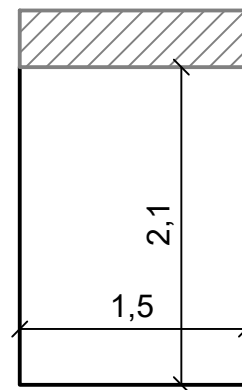

LEGENDA

- 00001PC16 Traccia Sezione Fluviale
- Punto di Rilievo
- Tratto Tombato con Sezione Tipo A
- Tratto Tombato con Sezione Tipo B
- Tratto Tombato con Sezione Tipo C
- Tratto Tombato con Sezione Tipo D
- Tratto Tombato con Sezione Tipo E - F

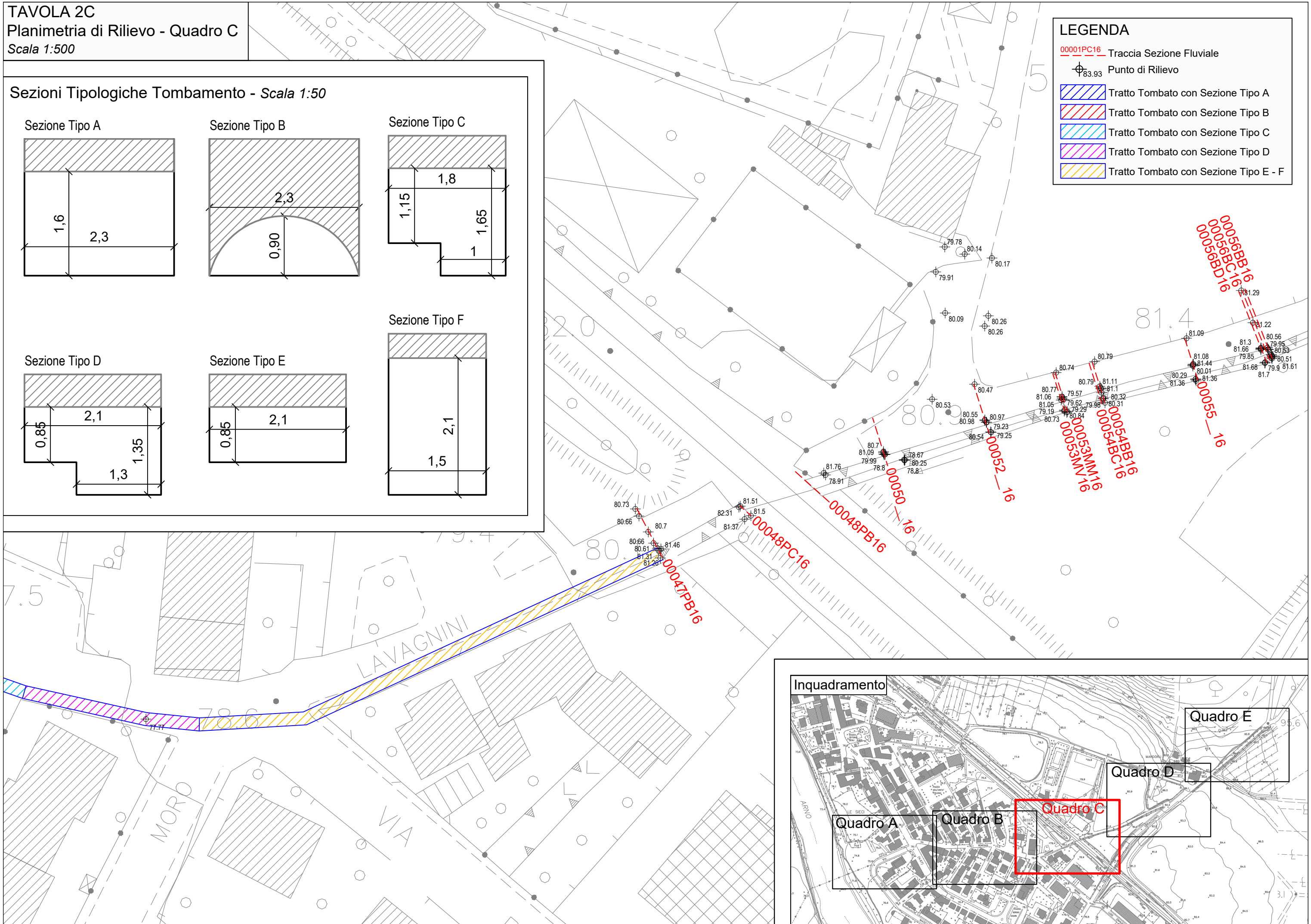

Inquadramento



TAVOLA 2E
Planimetria di Rilievo - Quadro E
Scala 1:500

LEGENDA

- 00001PC16 Traccia Sezione Fluviale
- ⊕_{83.93} Punto di Rilievo

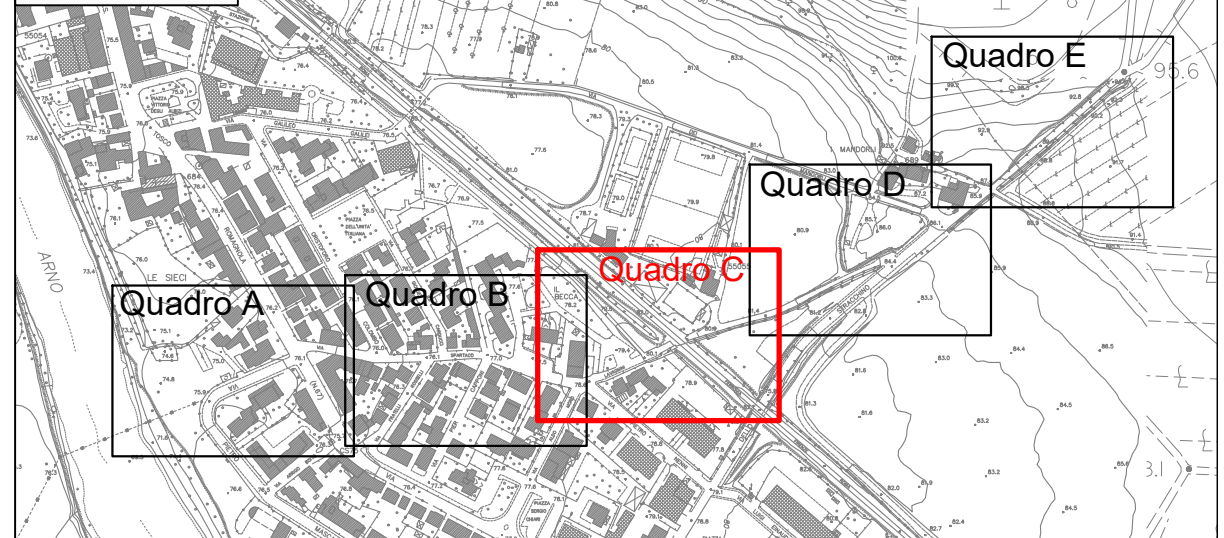

TAVOLA 3
Planimetria del Modello Idraulico
 Scala 1:2500



LEGENDA

Modello Digitale del Terreno [m s.l.m.]

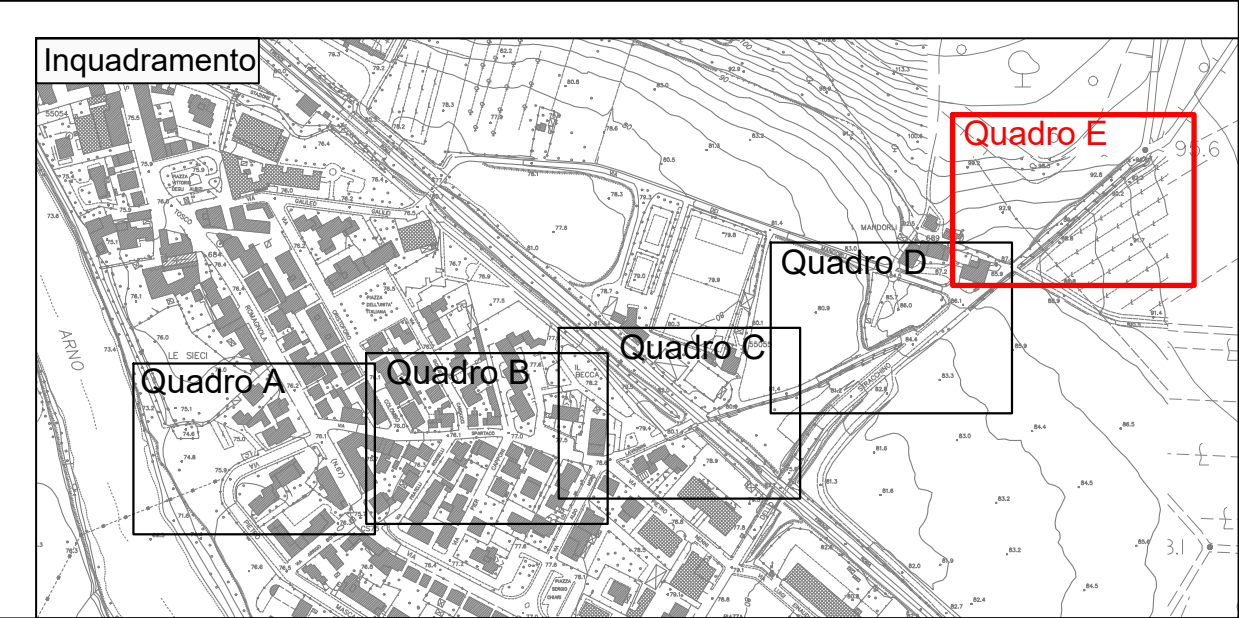
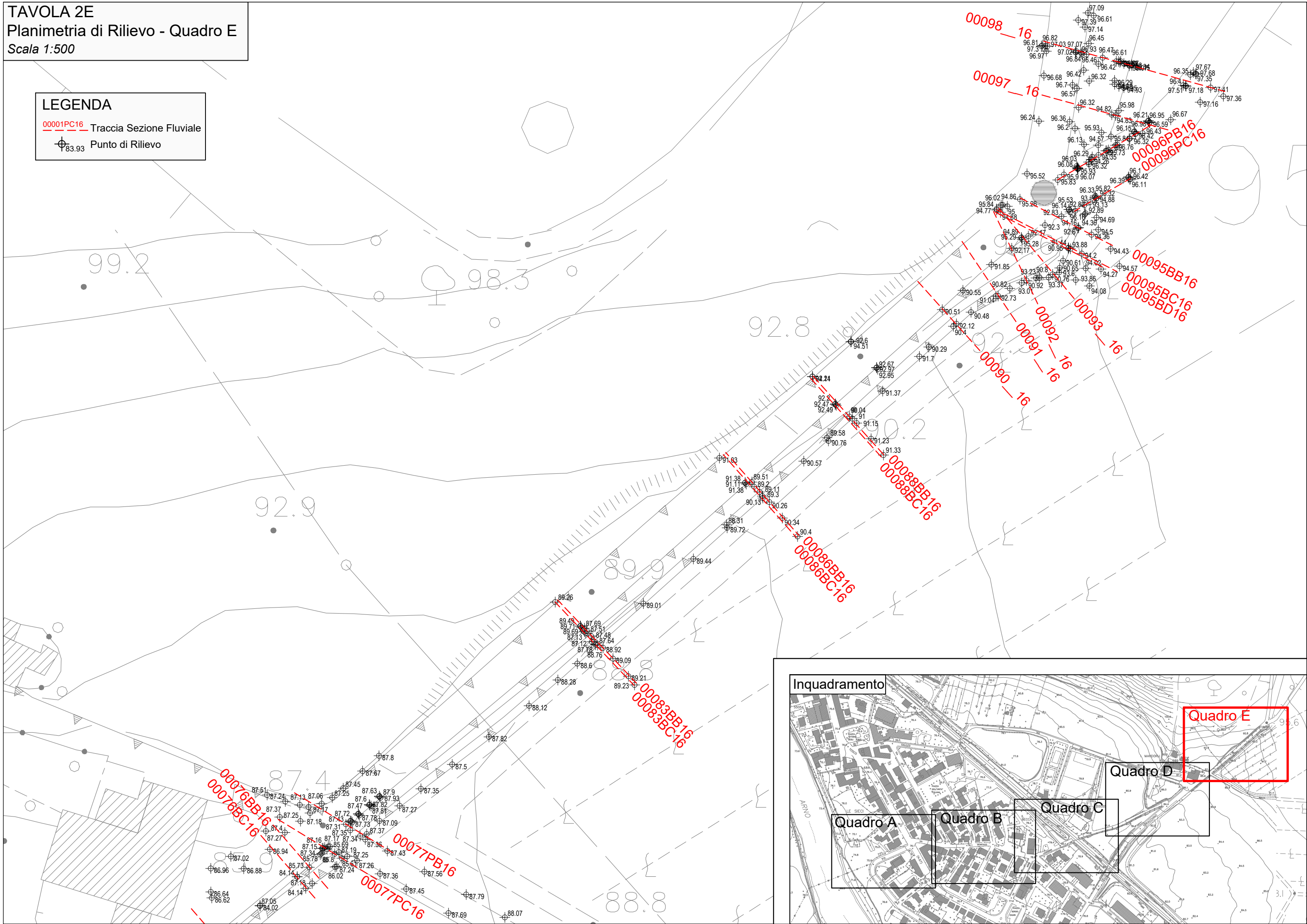
65 - 75
75 - 77.5
77.5 - 80
80 - 82.5
82.5 - 85
85 - 87.5
87.5 - 90
90 - 92.5
92.5 - 95
95 - 100
100 - 115
115 - 130
oltre 130

00001PC16 Traccia Sezione Fluviale

TAVOLA 4

Libretto Sezioni con Livelli Idrometrici

Tr 30 – 200 – 500 Anni

SEZIONE N° 00098__16

LEGENDA:

Livelli Idrometrici Tr30 H =96.55 m. s.l.m.

Livelli Idrometrici Tr200 H =96.94 m. s.l.m.

Livelli Idrometrici Tr500 H =97.09 m. s.l.m.

SCALA DISTANZE 1:100
SCALA QUOTE 1:100

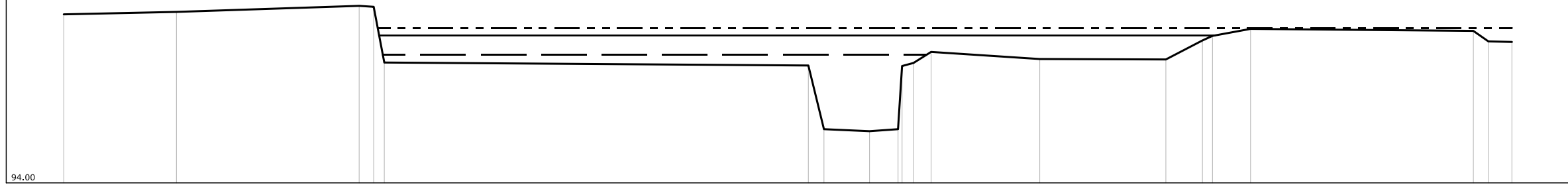

PUNTI	1	2	3	4	5	6	7	8	9	11	12	13	14	15	16	17	18	19	20
QUOTE [m s.l.m.]	97.36	97.41	97.53	97.51	96.40	96.34	95.07	95.03	95.07	96.39	96.61	96.47	96.46	96.84	96.93	97.07	97.03	96.82	96.81
DISTANZE PROGRESSIVE [m]	0.00	2.25	5.90	6.19	6.40	14.87	15.18	16.09	16.66	16.97	17.32	19.49	22.01	22.74	22.94	23.70	28.15	28.45	28.92
DISTANZE PARZIALI [m]		2.25	3.65			8.47		0.91	0.57			2.17		2.52	0.73	0.76	4.45		

SEZIONE N° 00097__16

LEGENDA:

Livelli Idrometrici Tr30 H =96.32 m. s.l.m.

Livelli Idrometrici Tr200 H =96.66 m. s.l.m.

Livelli Idrometrici Tr500 H =96.79 m. s.l.m.

SCALA DISTANZE 1:100
SCALA QUOTE 1:100

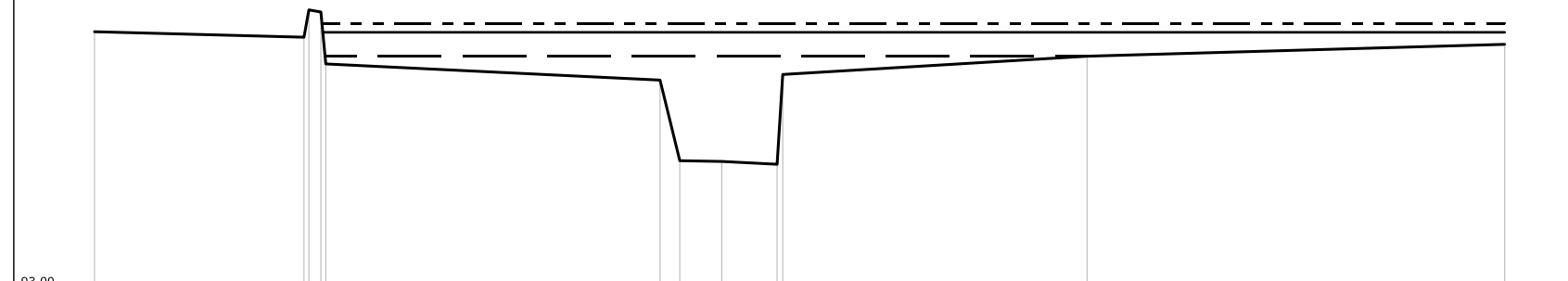

PUNTI	1	2	4	6	7	8	9	11	12
QUOTE [m s.l.m.]	96.67	96.59	96.95	95.98	94.83	94.82	94.78	96.32	96.49
DISTANZE PROGRESSIVE [m]	0.00	2.99	3.23	8.07	8.35	8.95	9.74	14.16	20.12
DISTANZE PARZIALI [m]		2.99		4.77		0.60	0.79	4.34	5.96

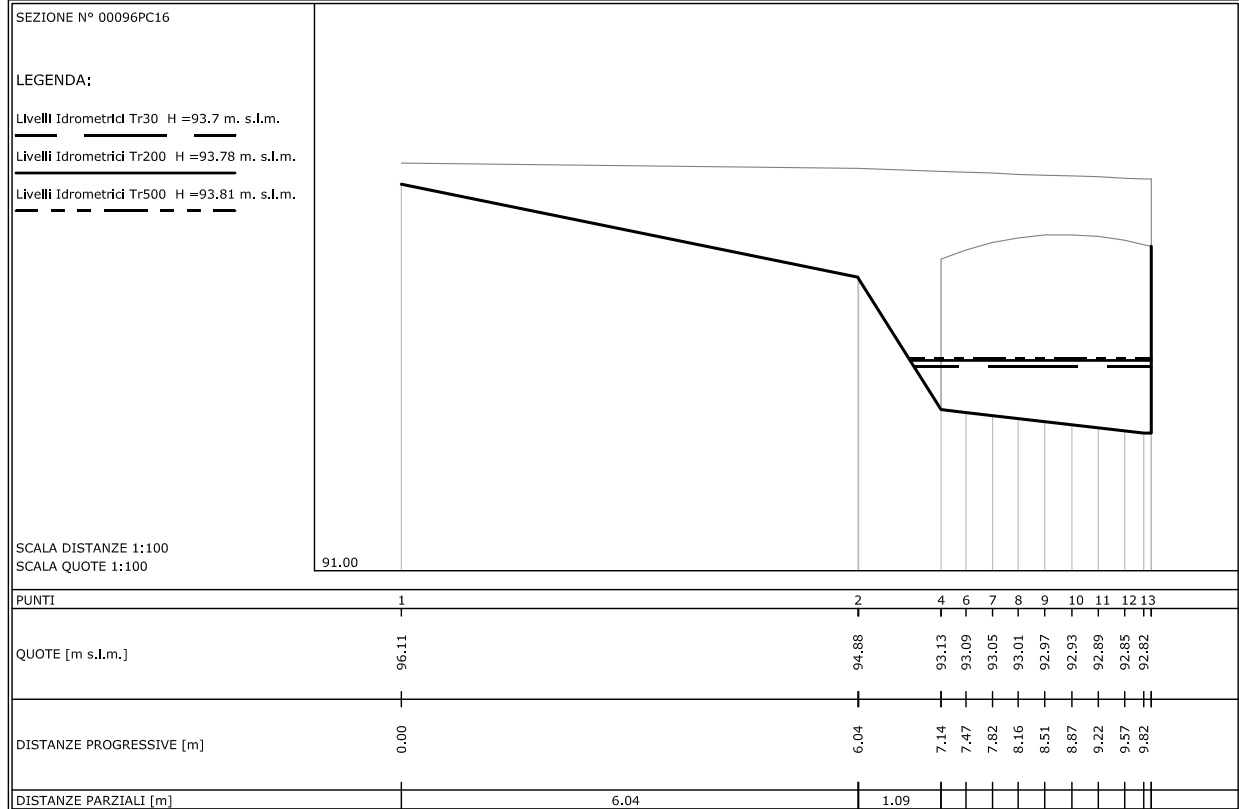
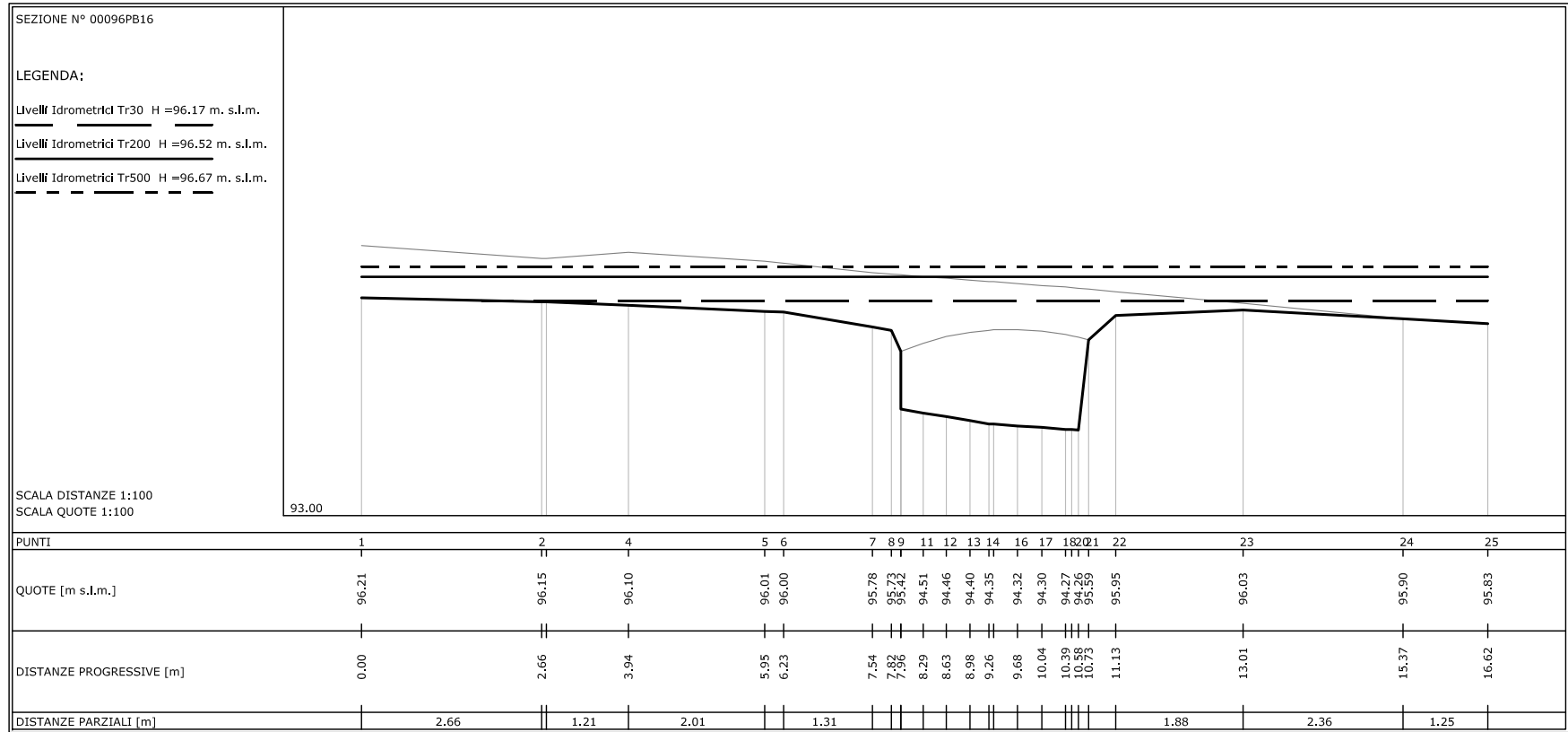

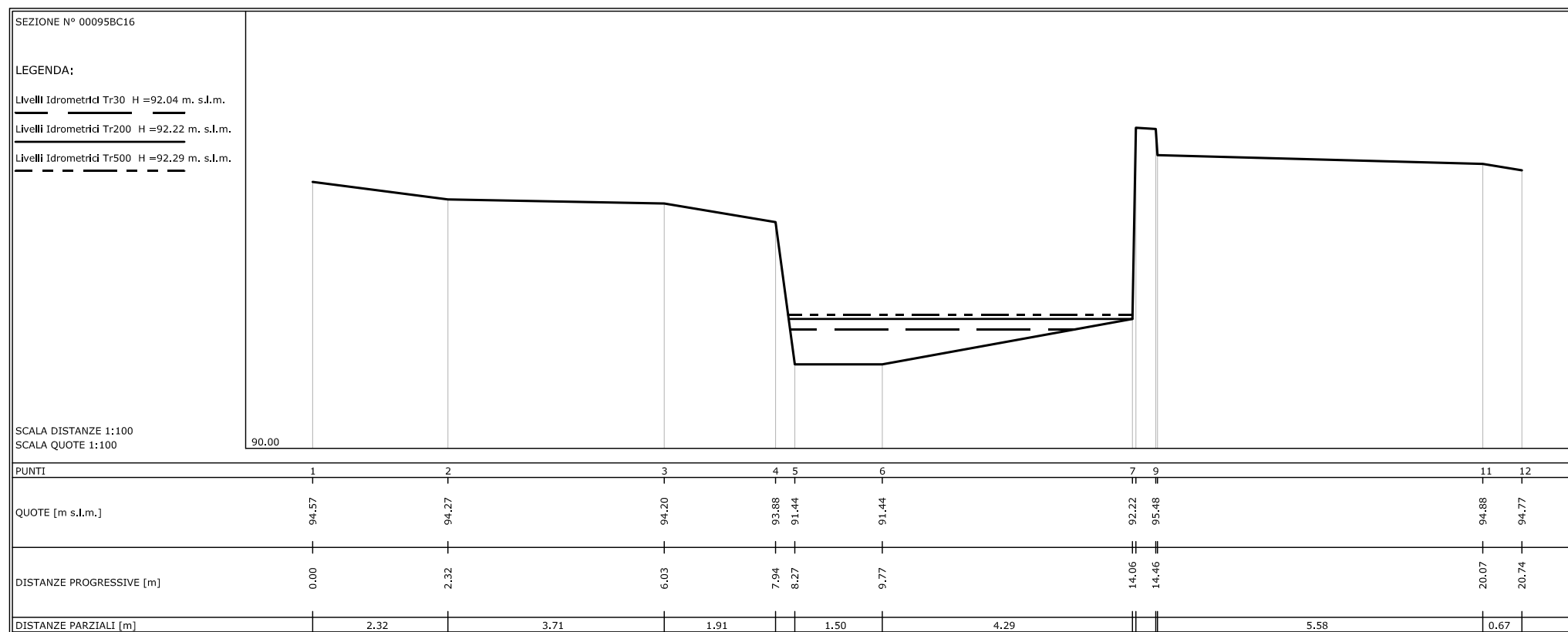
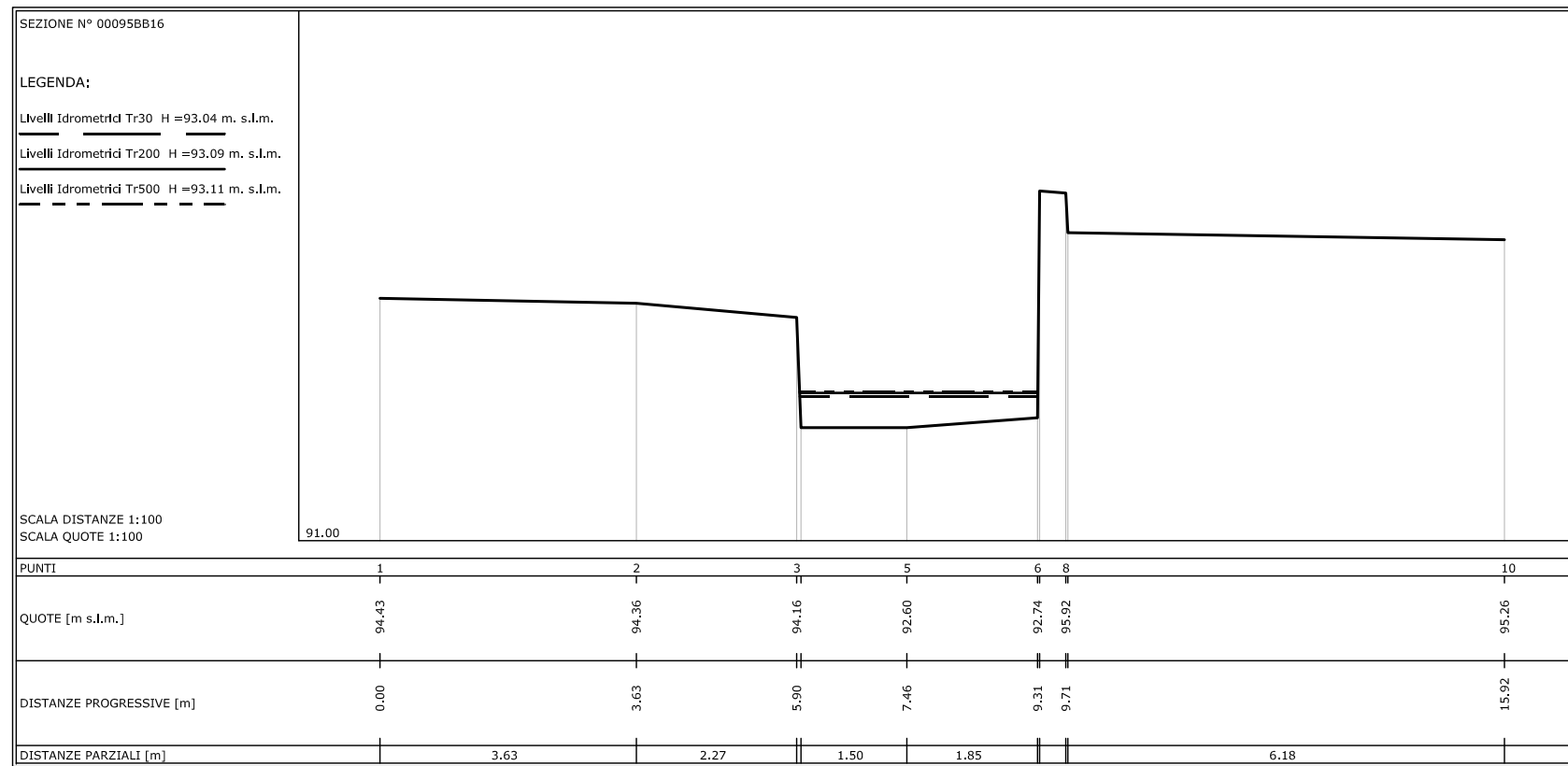

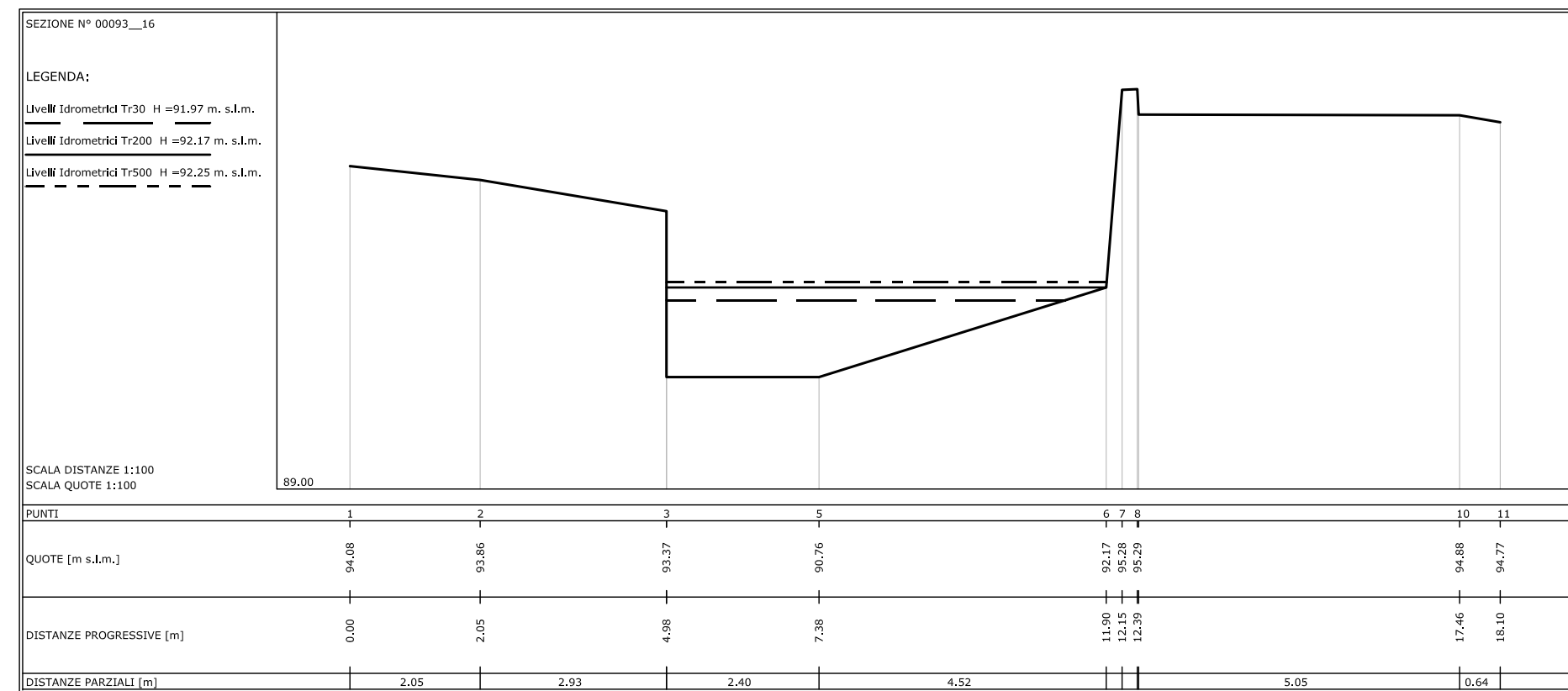
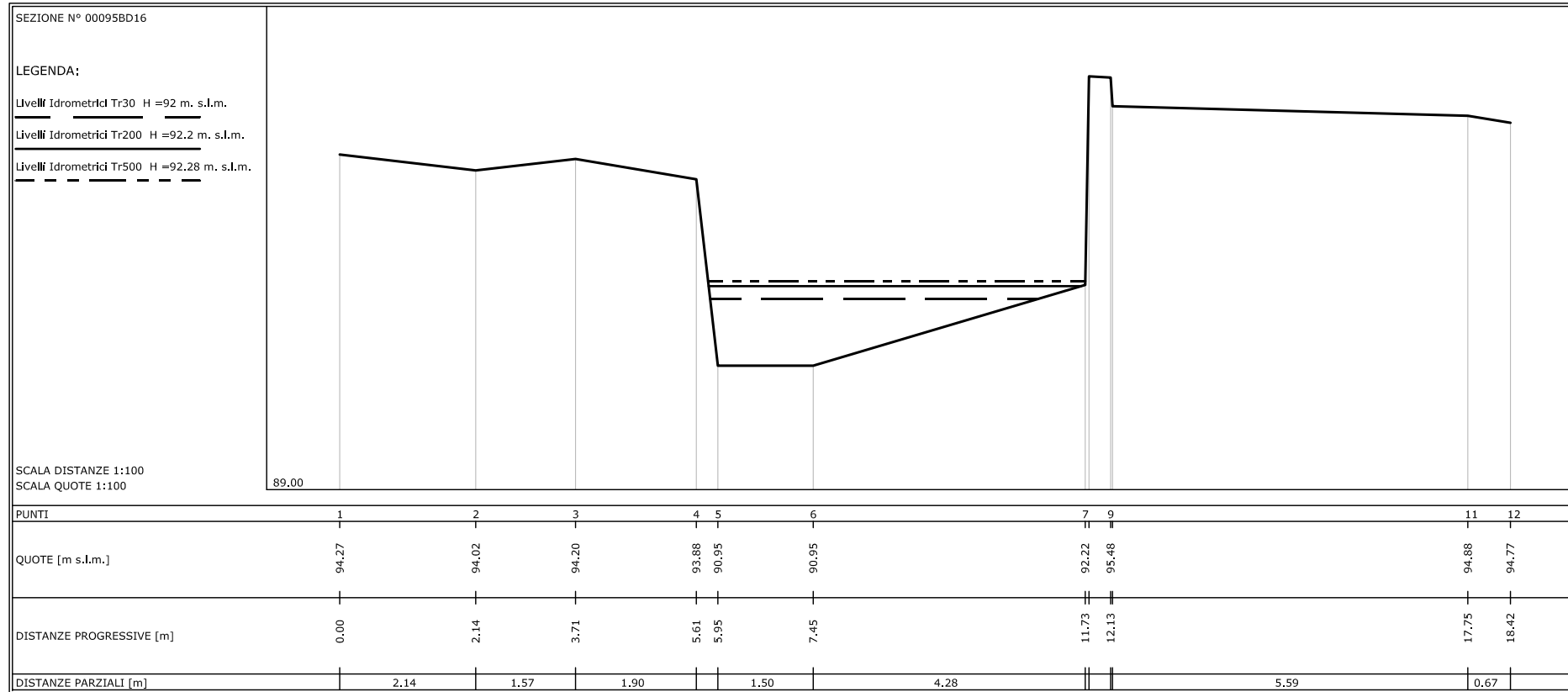

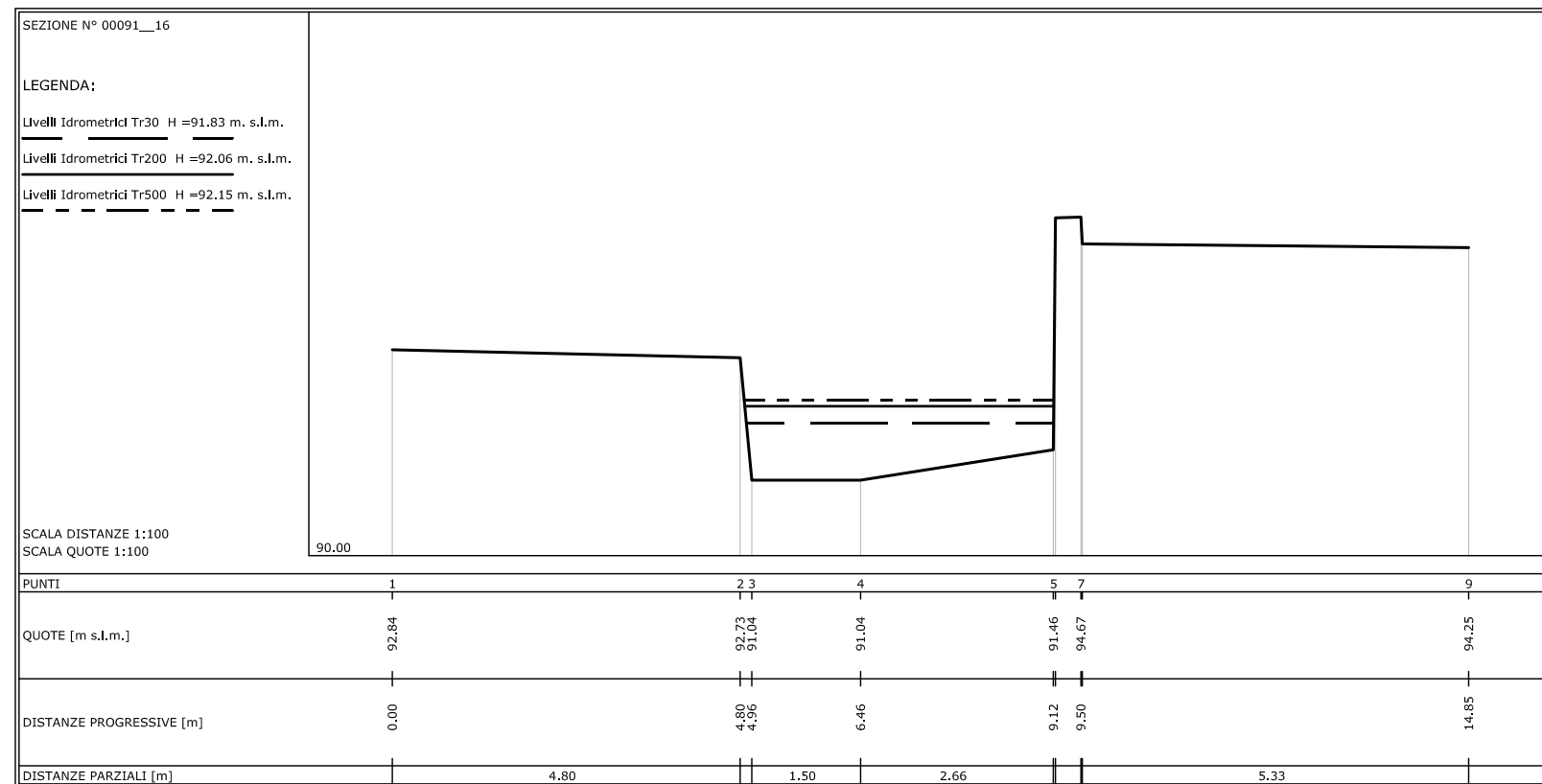
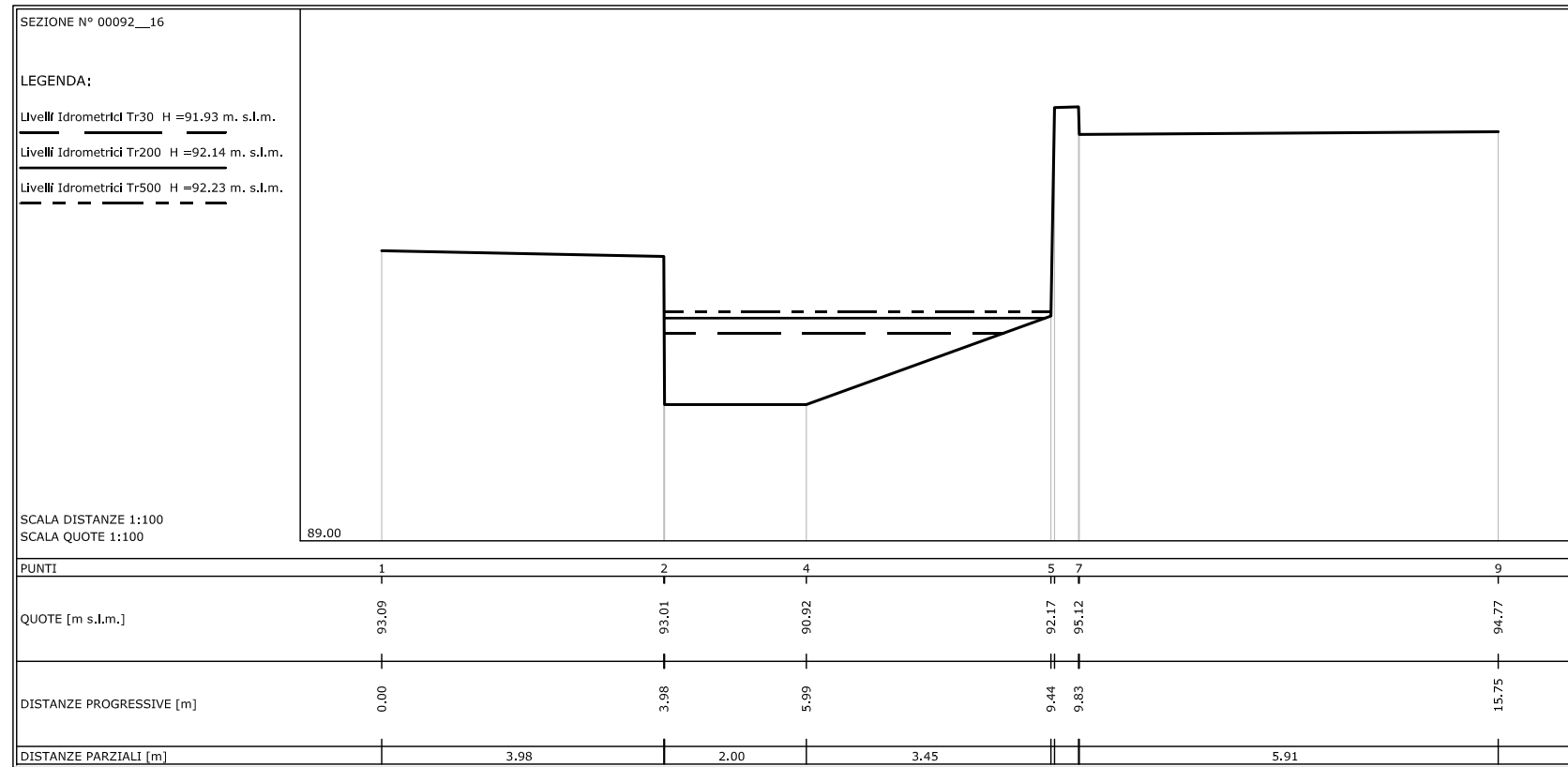

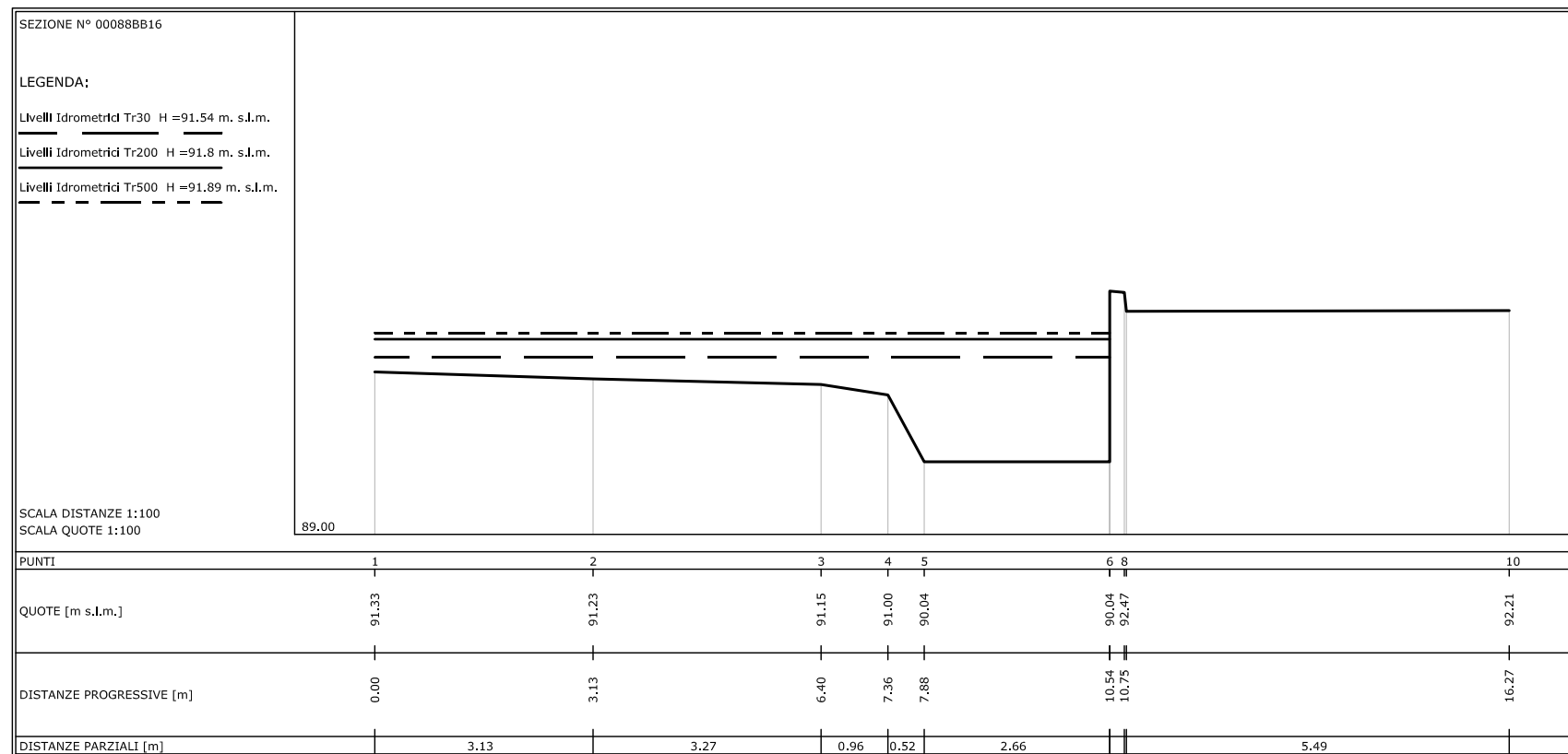
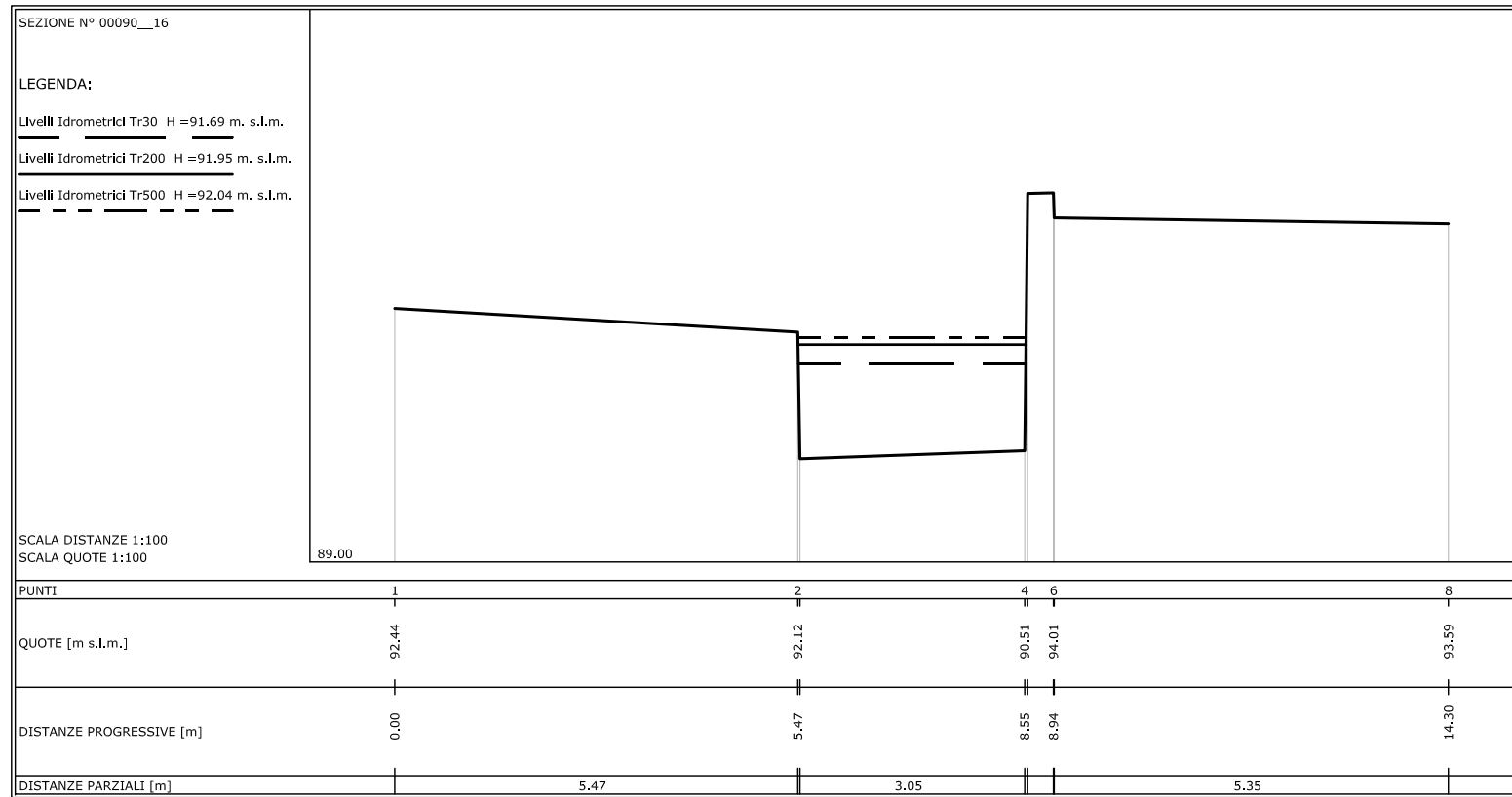

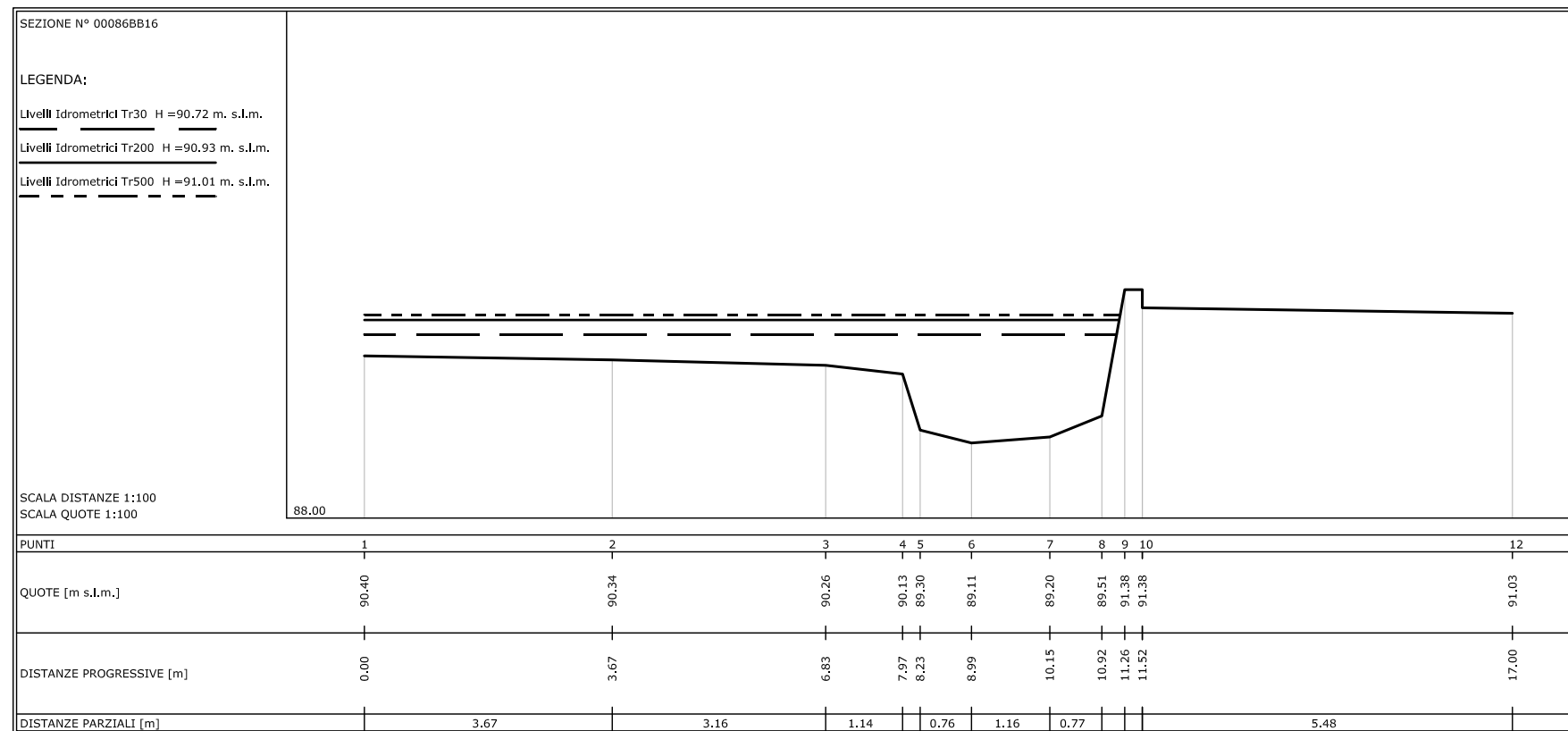
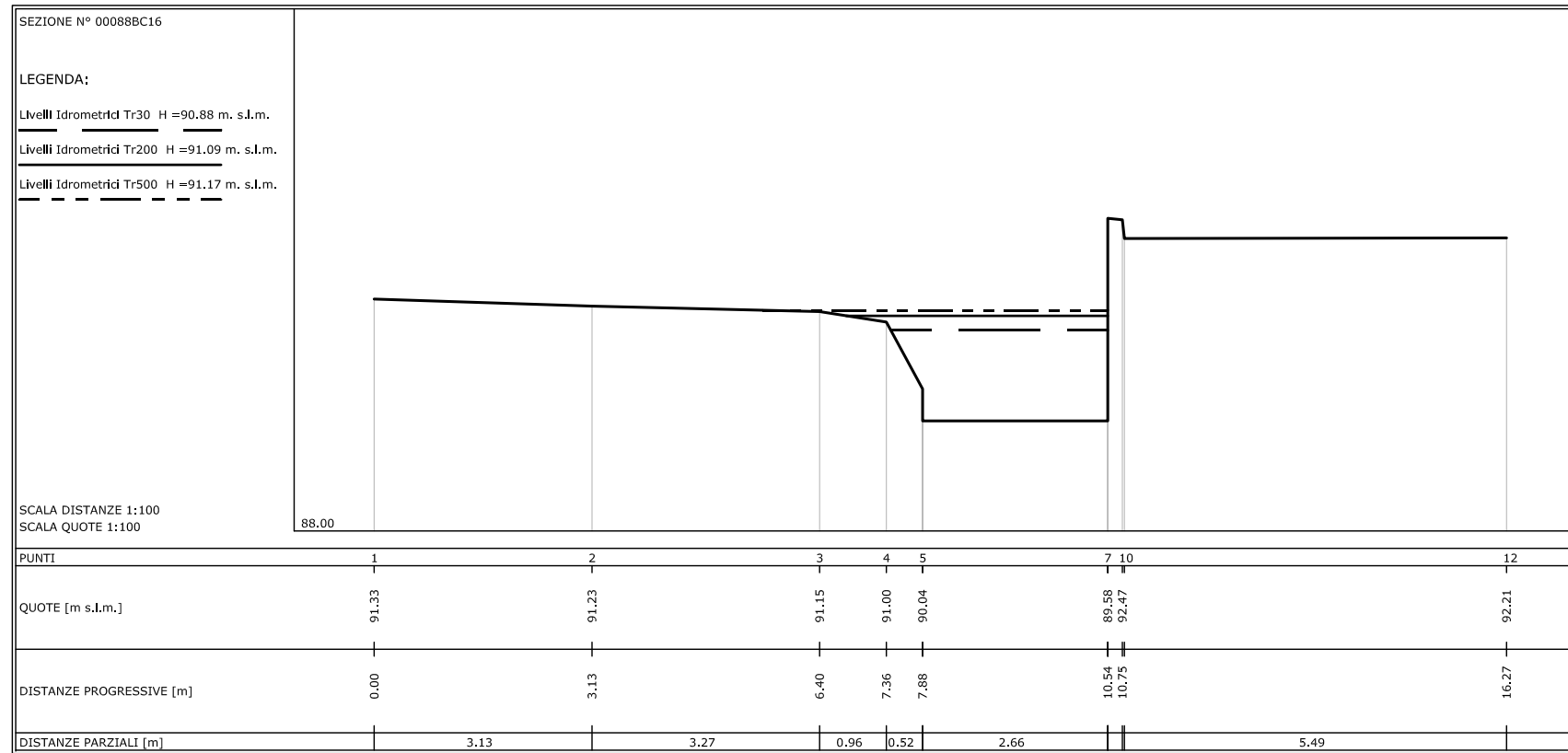

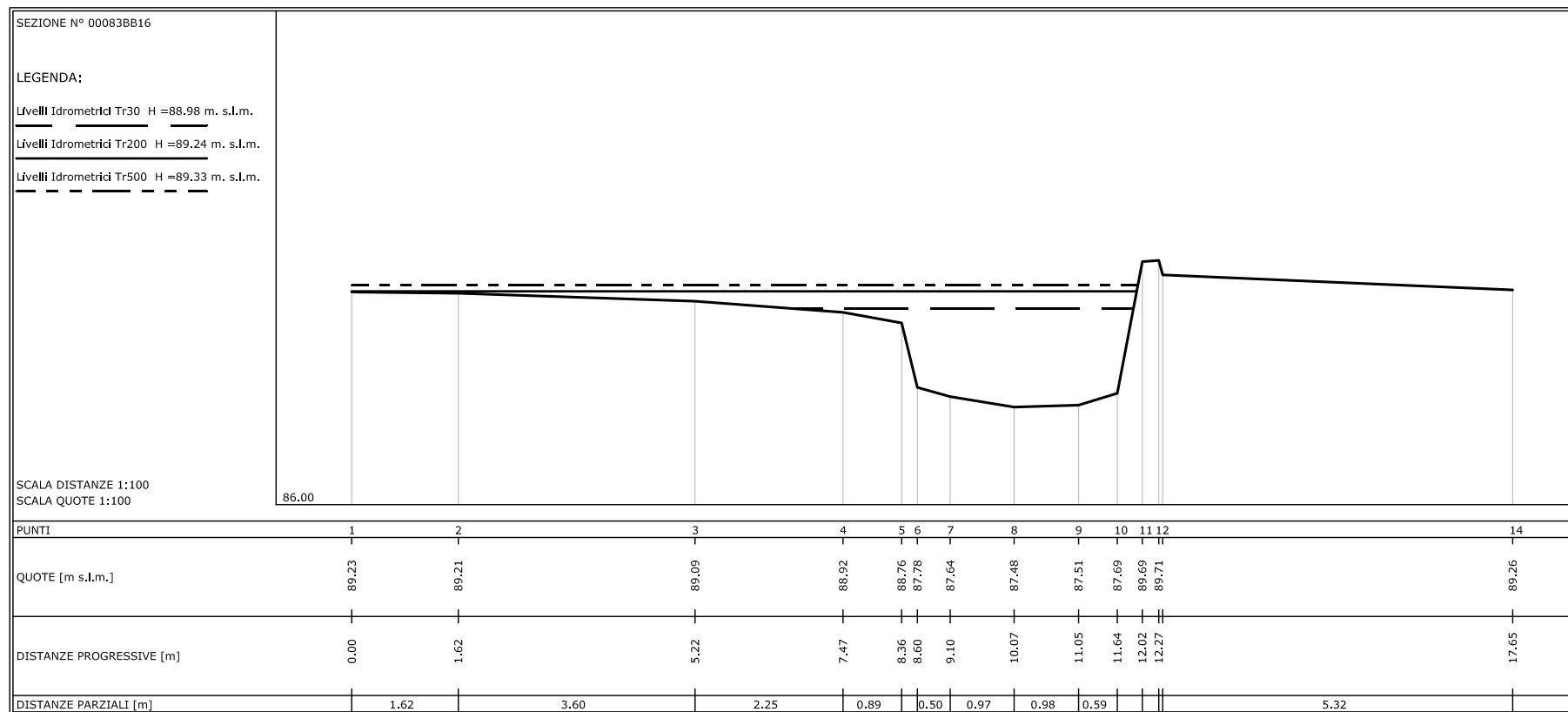
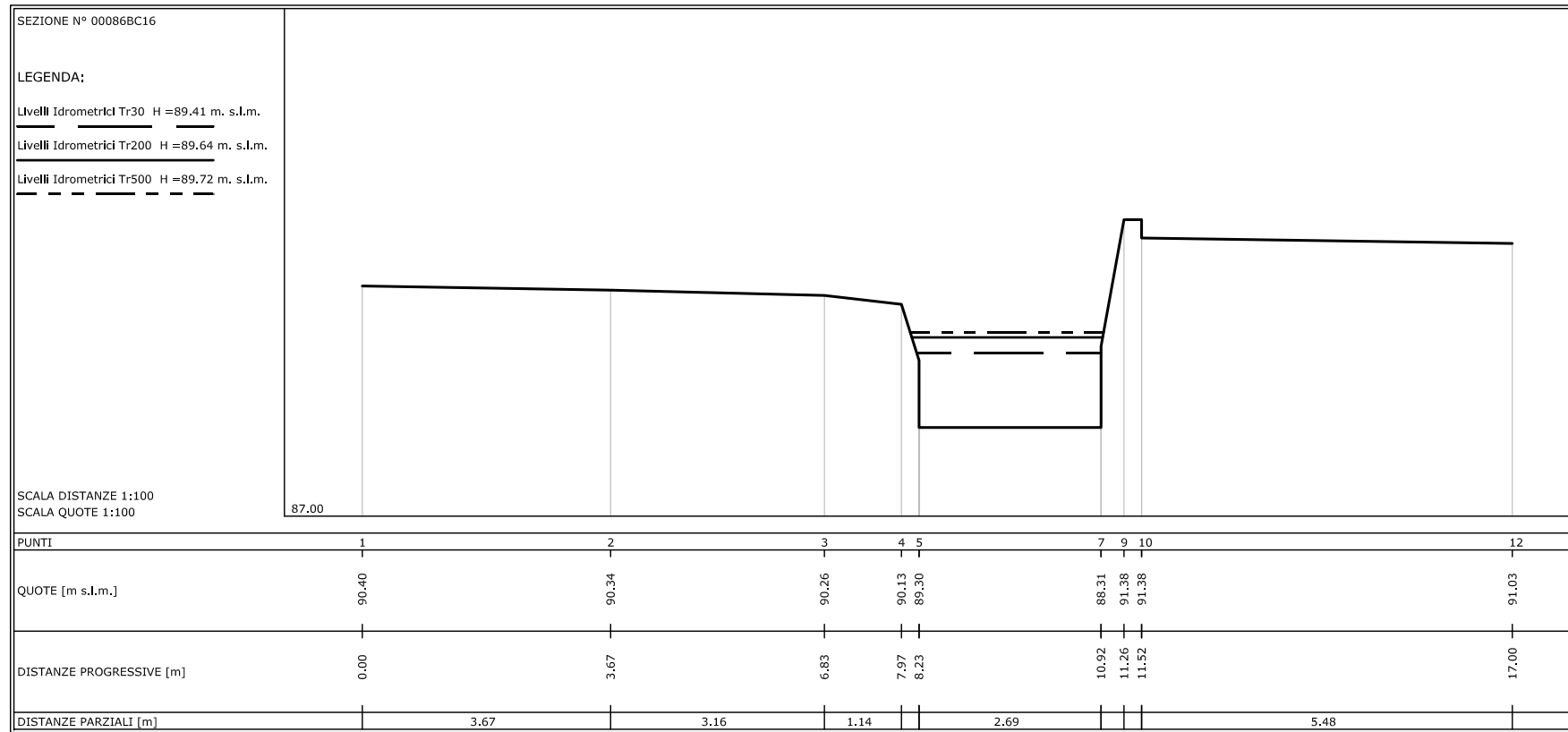

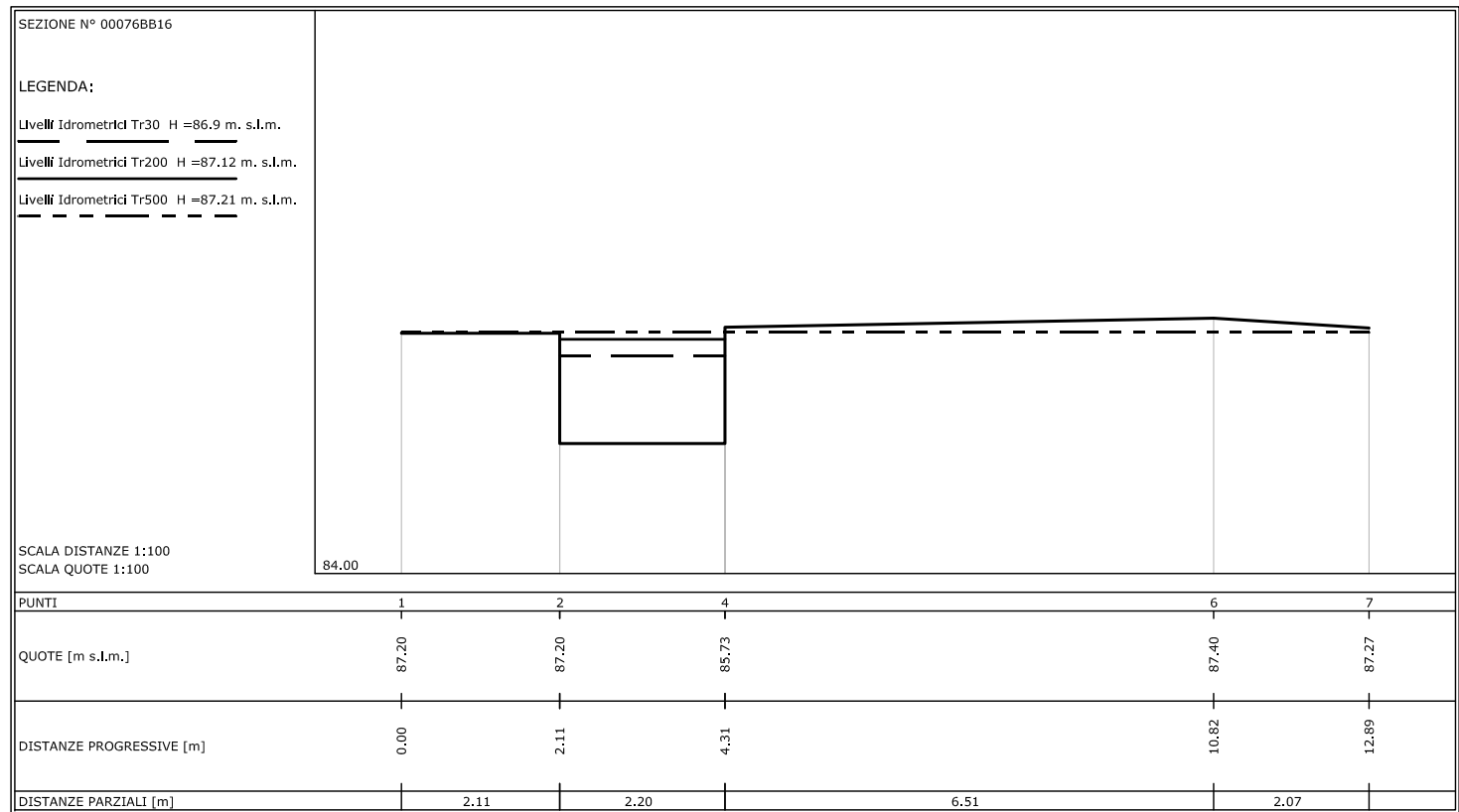
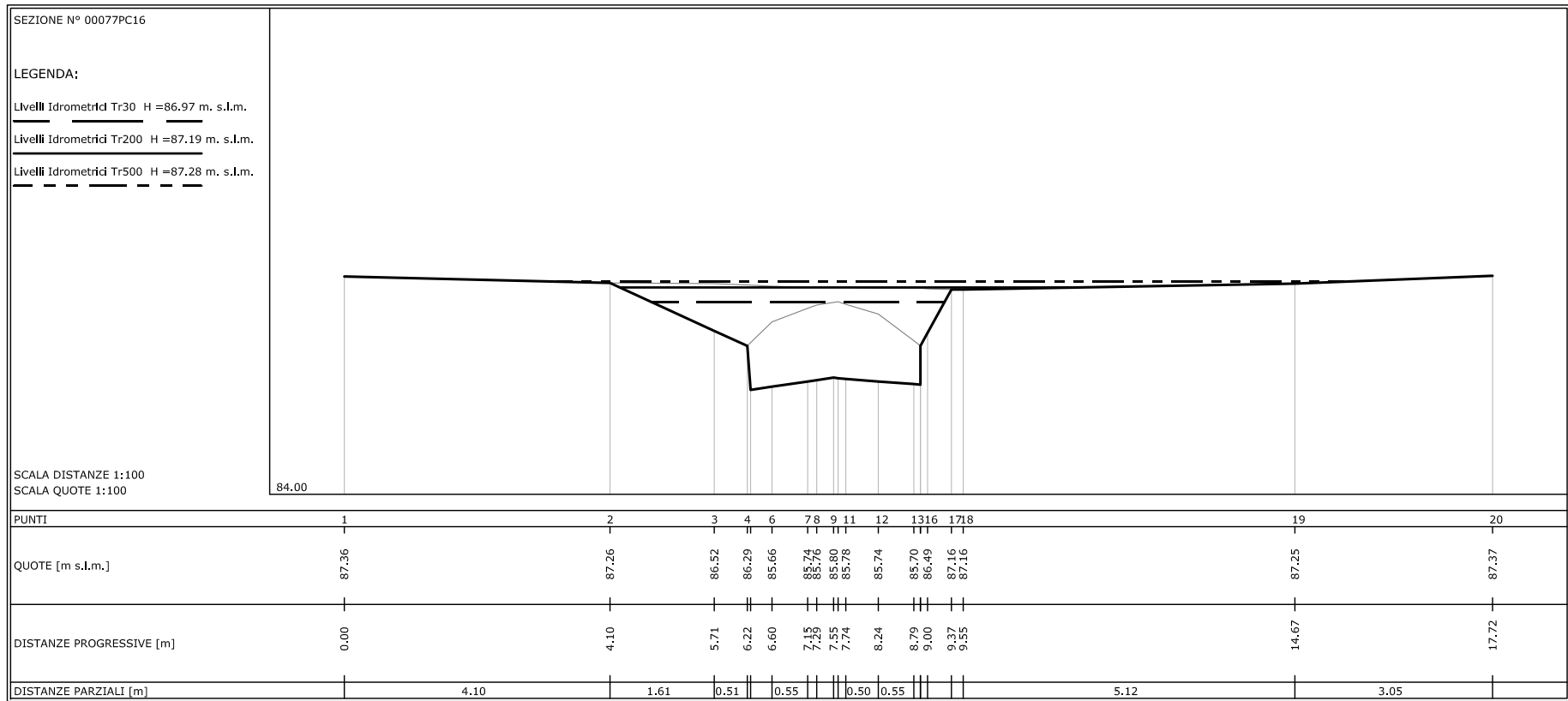

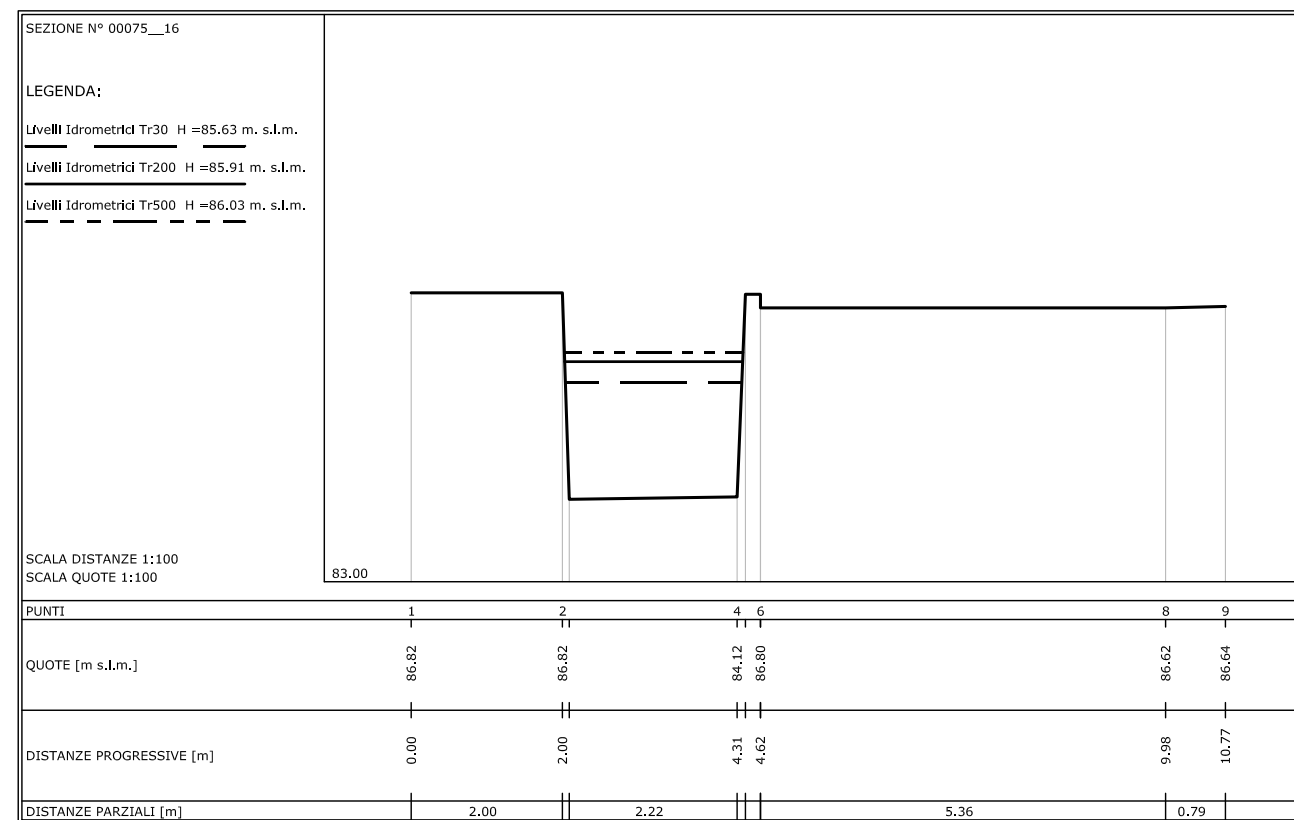
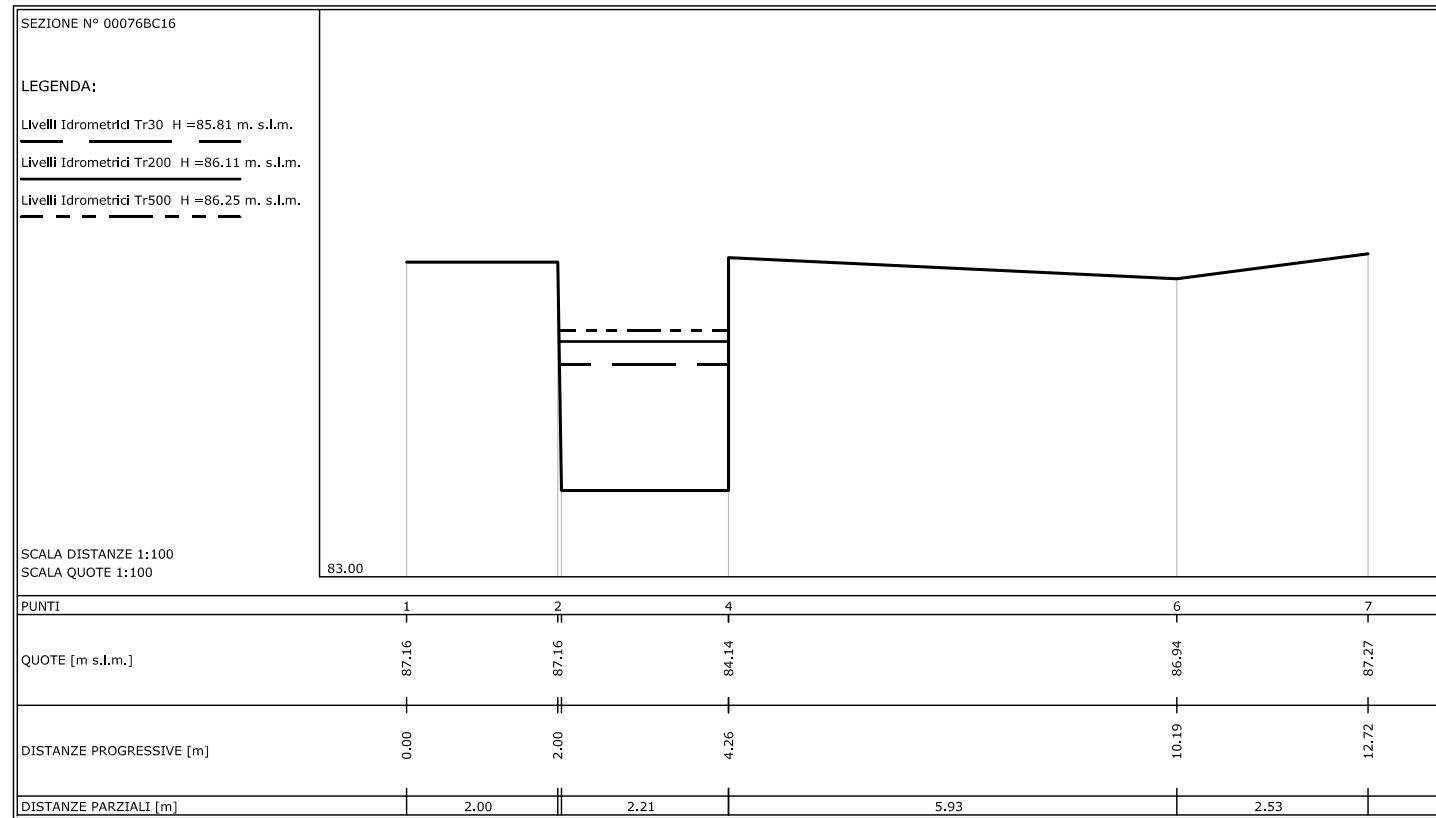

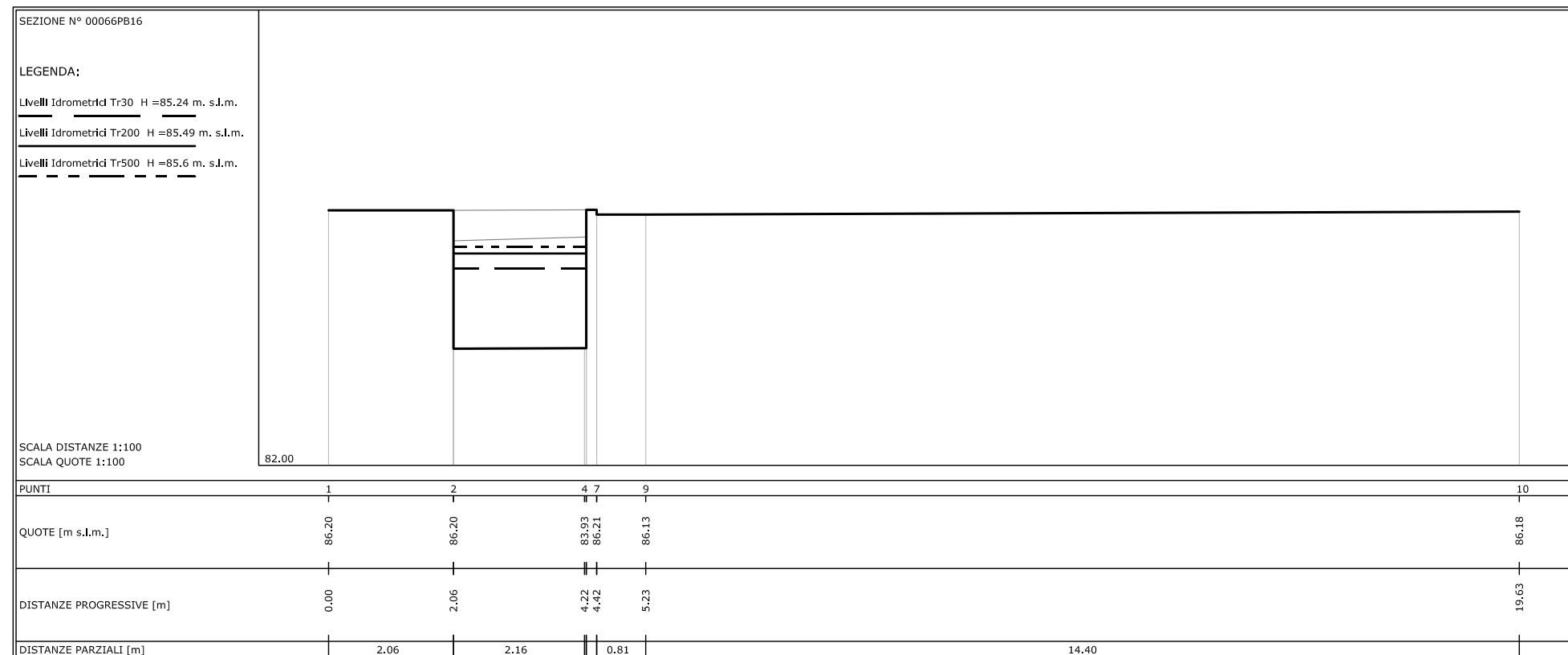
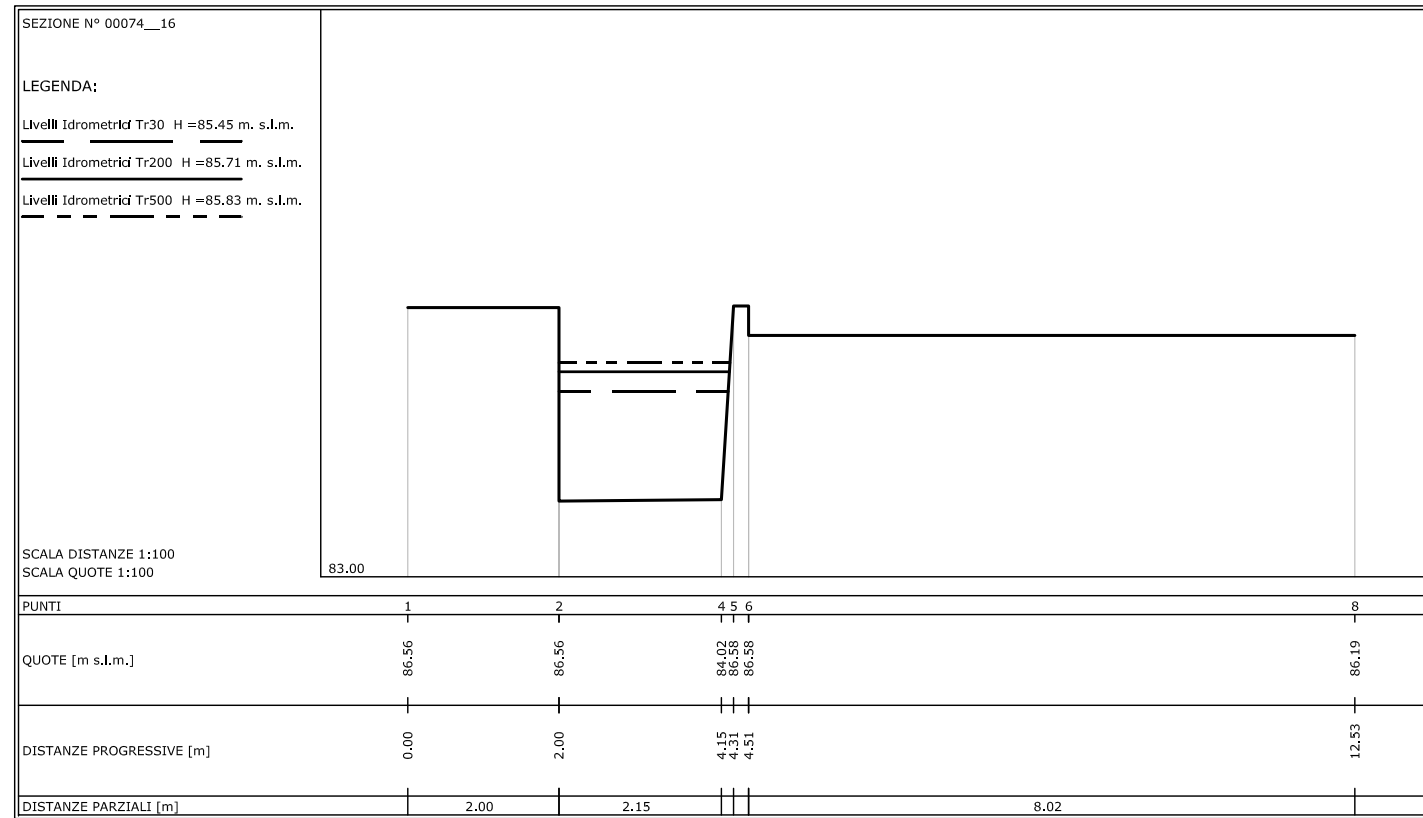

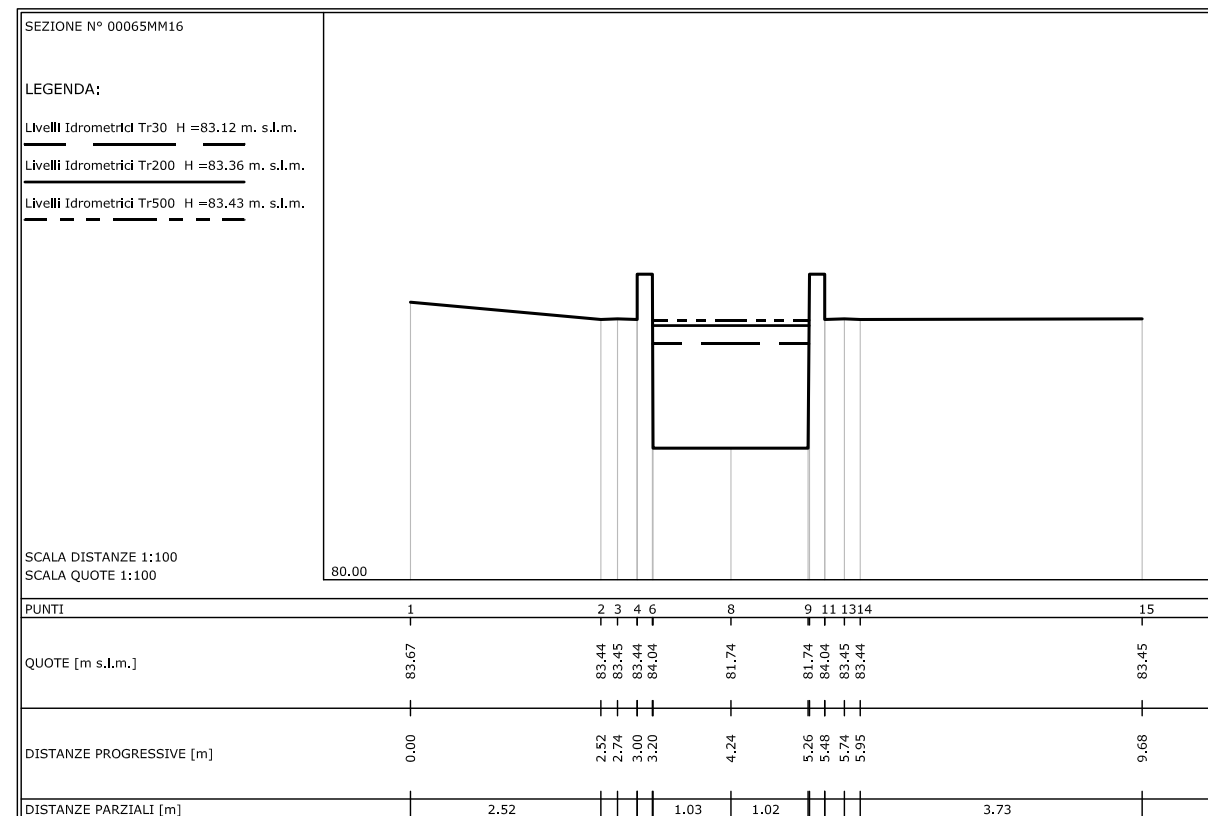
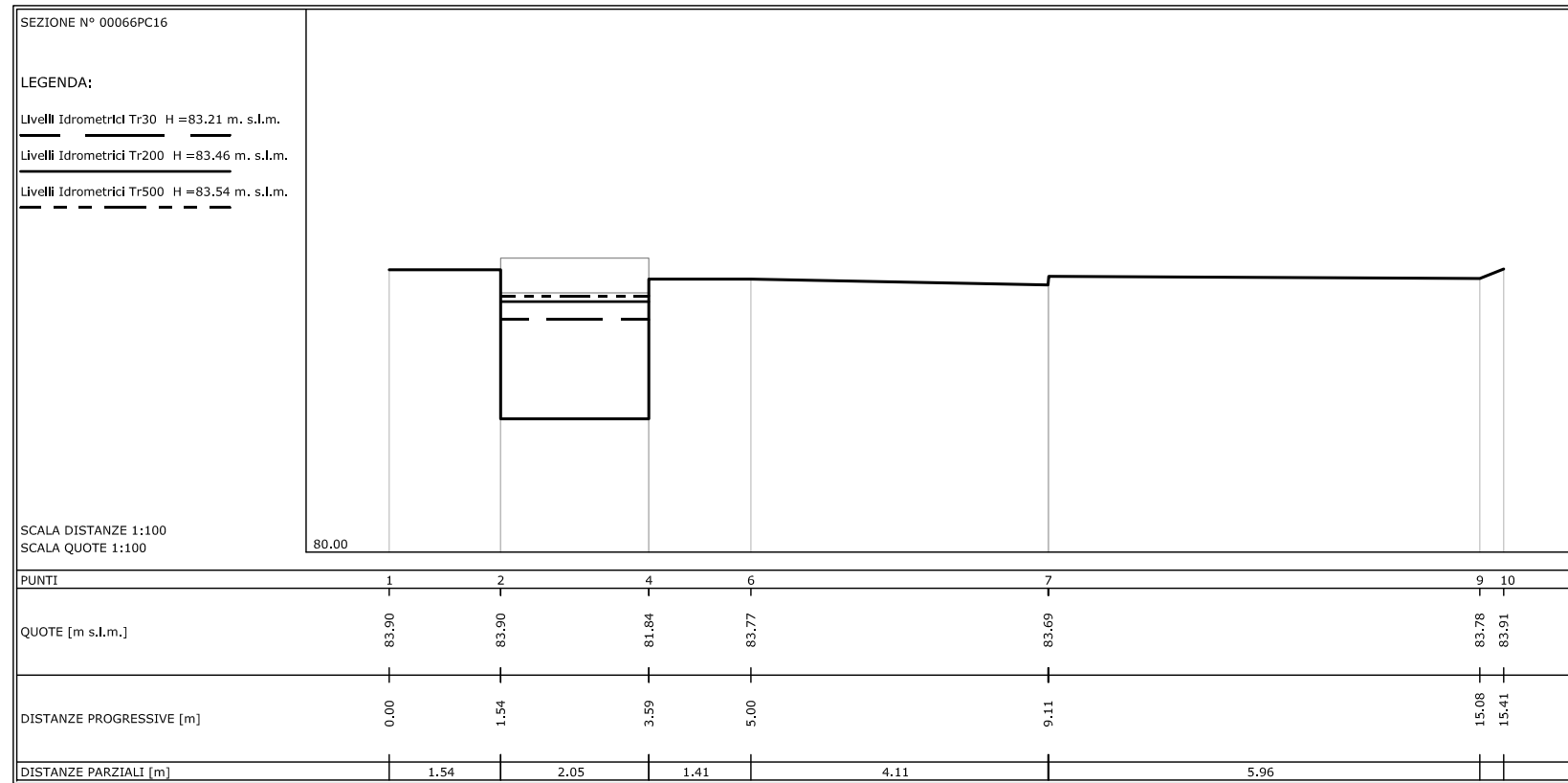

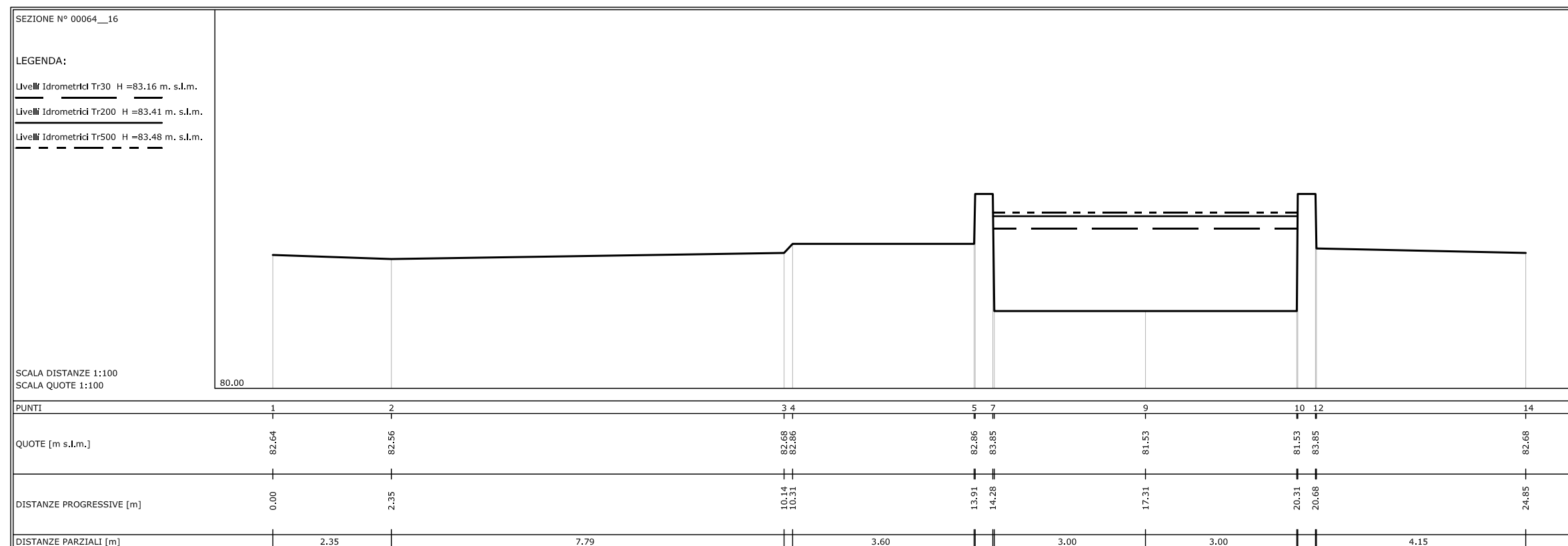
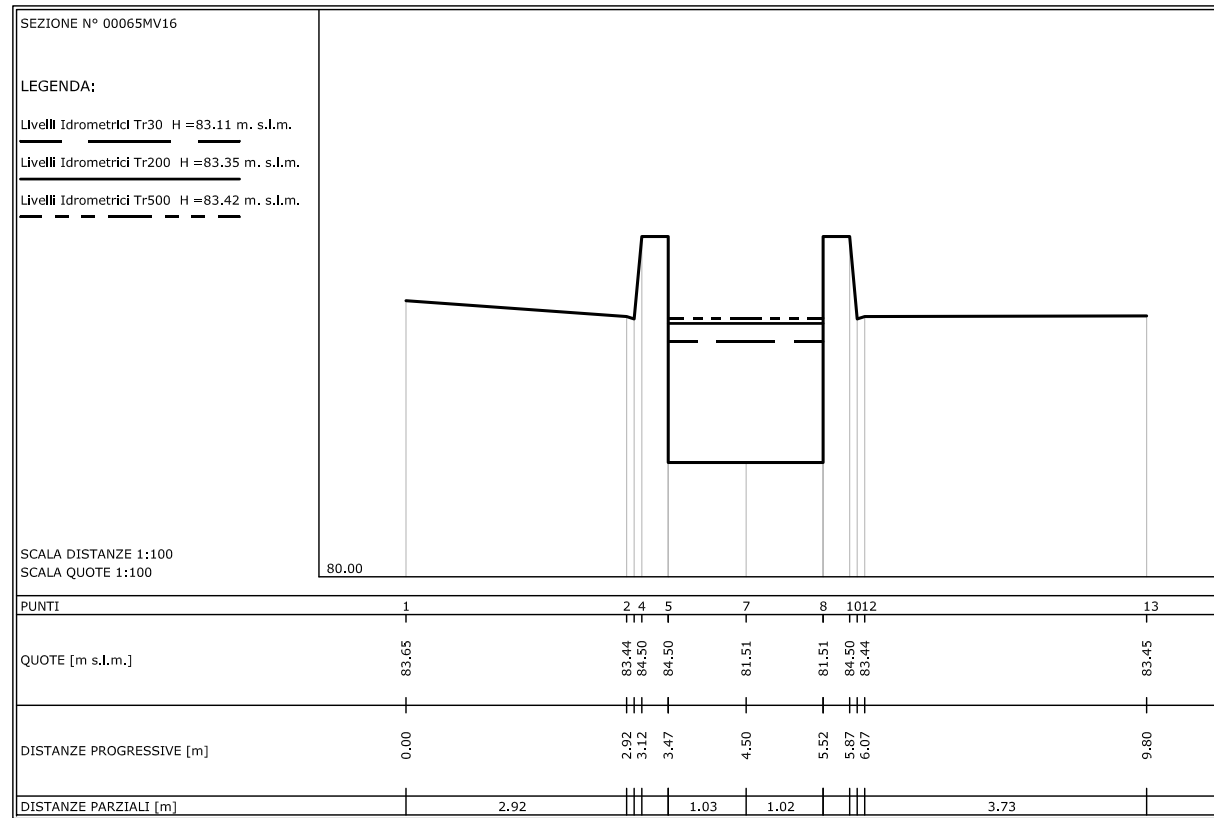

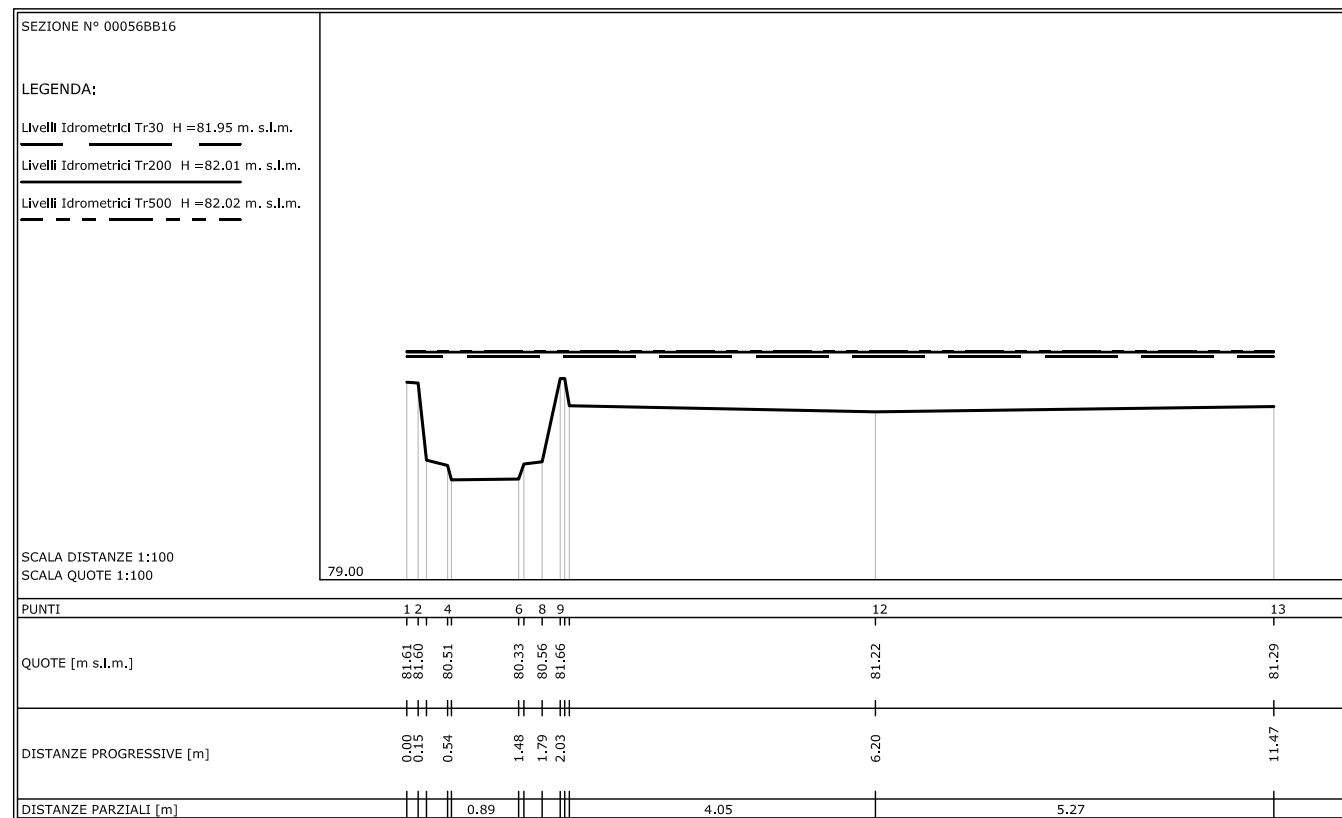
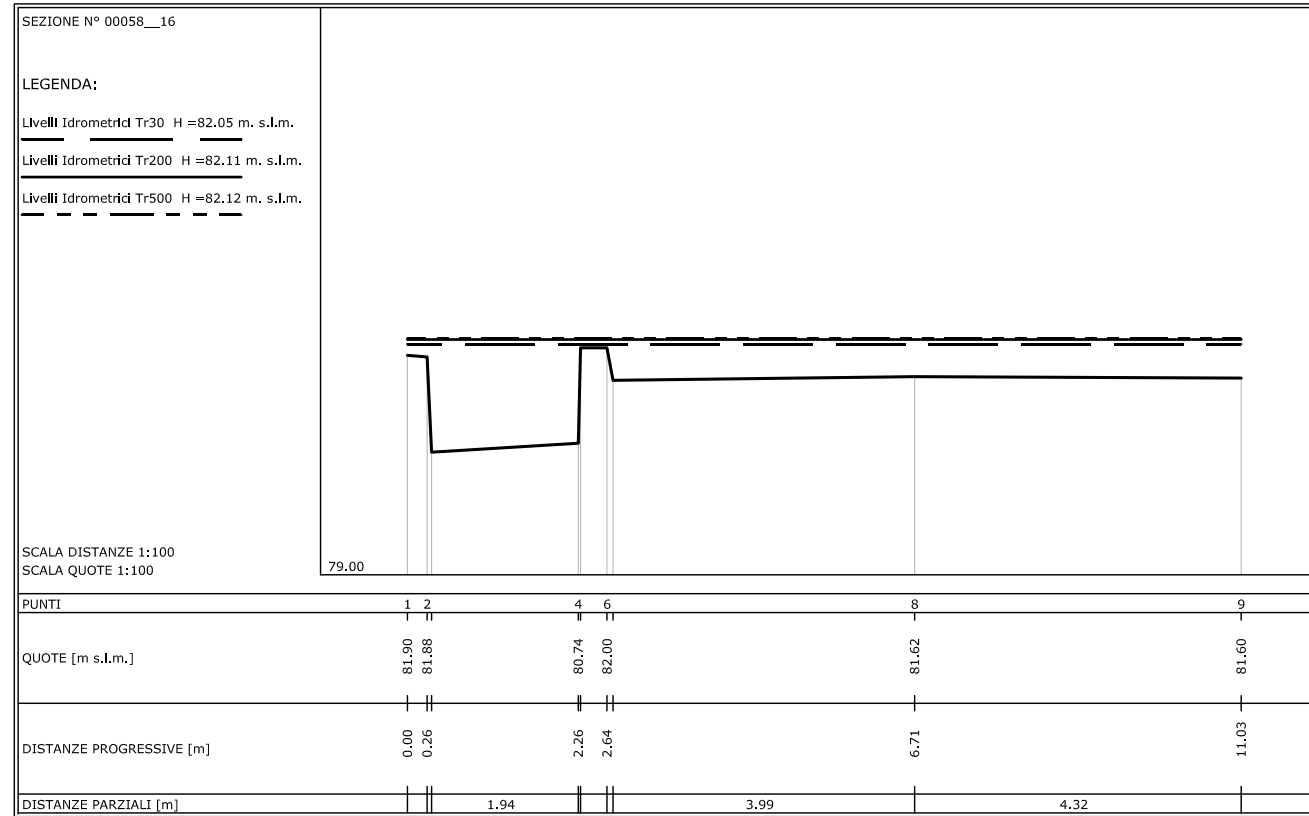

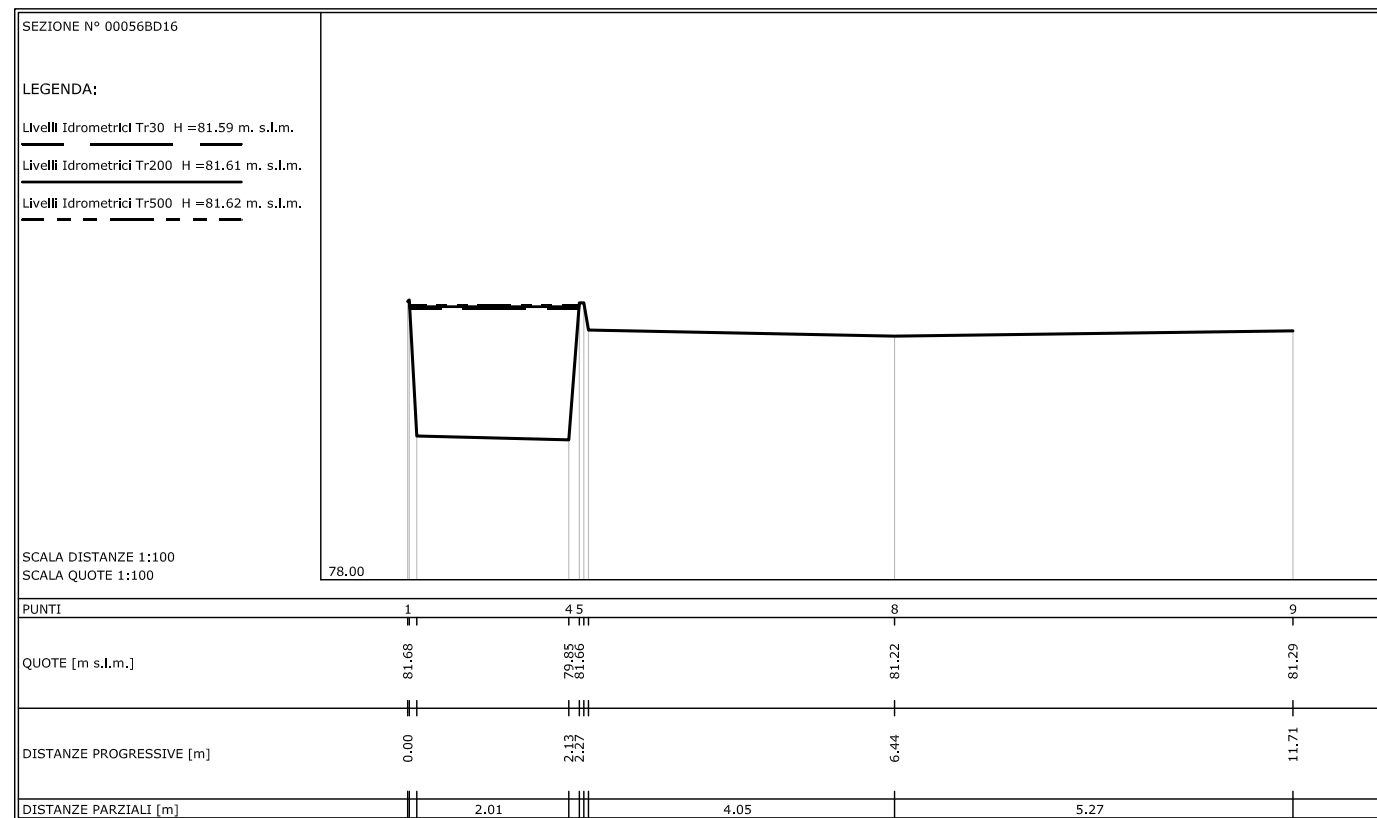
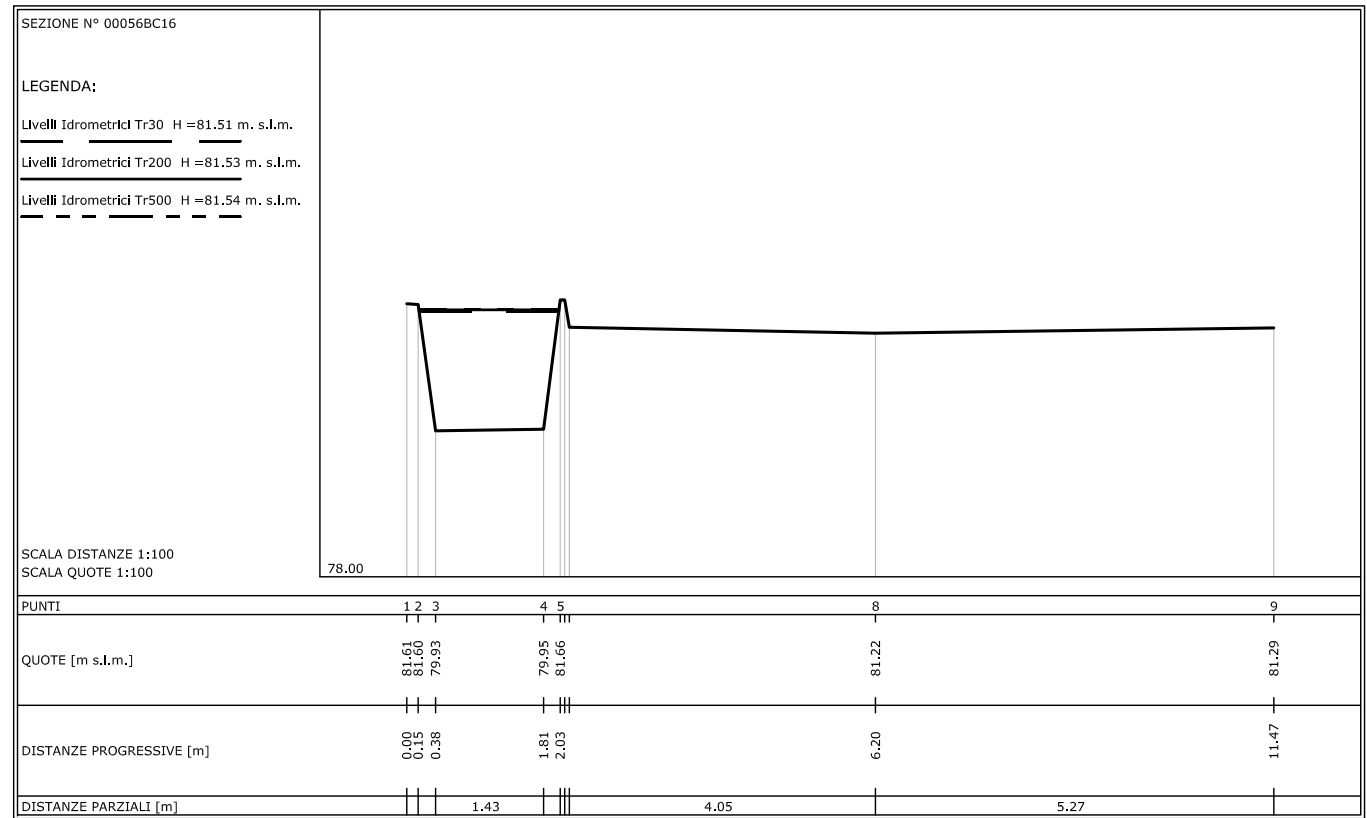

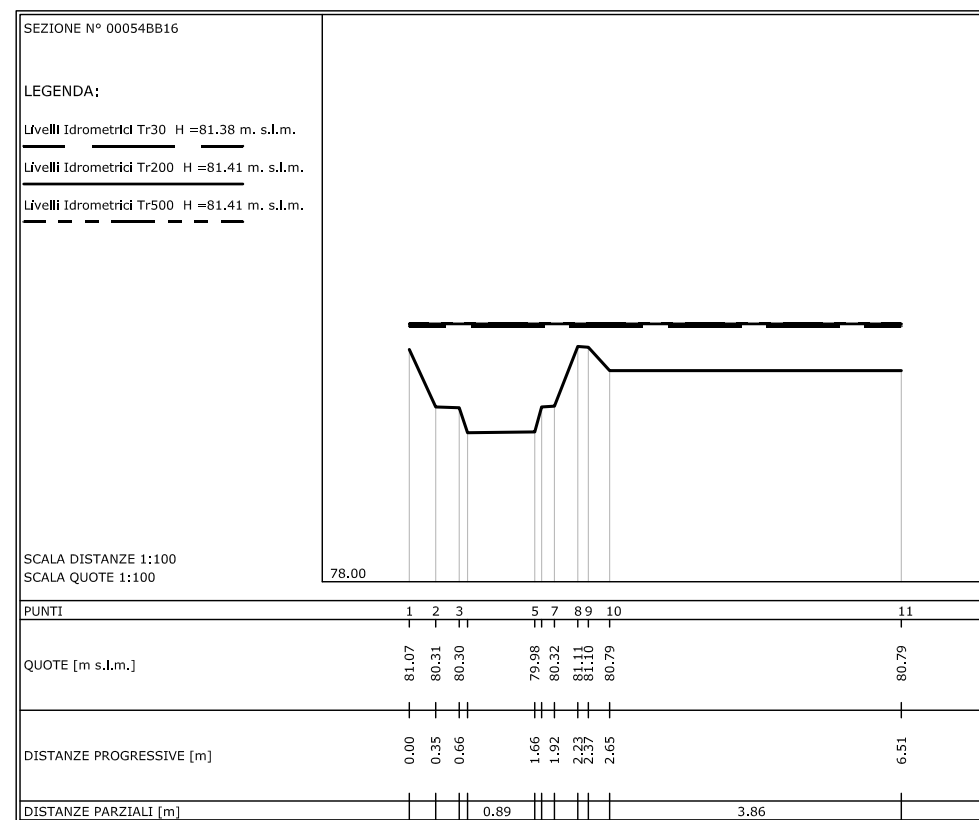
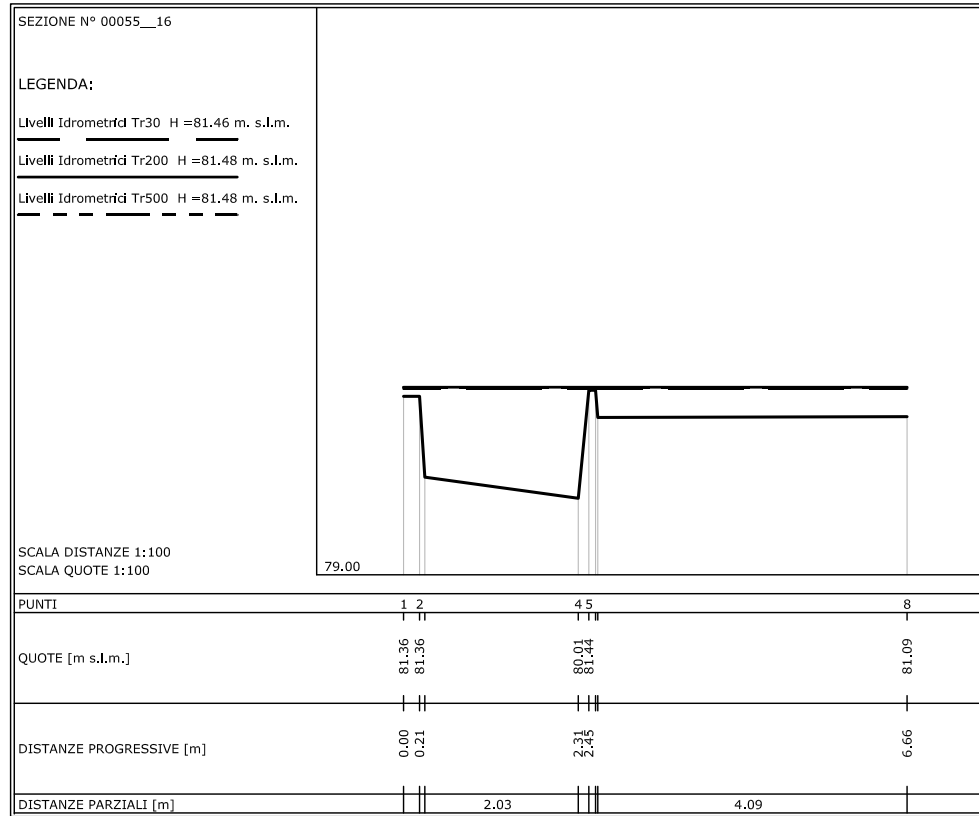

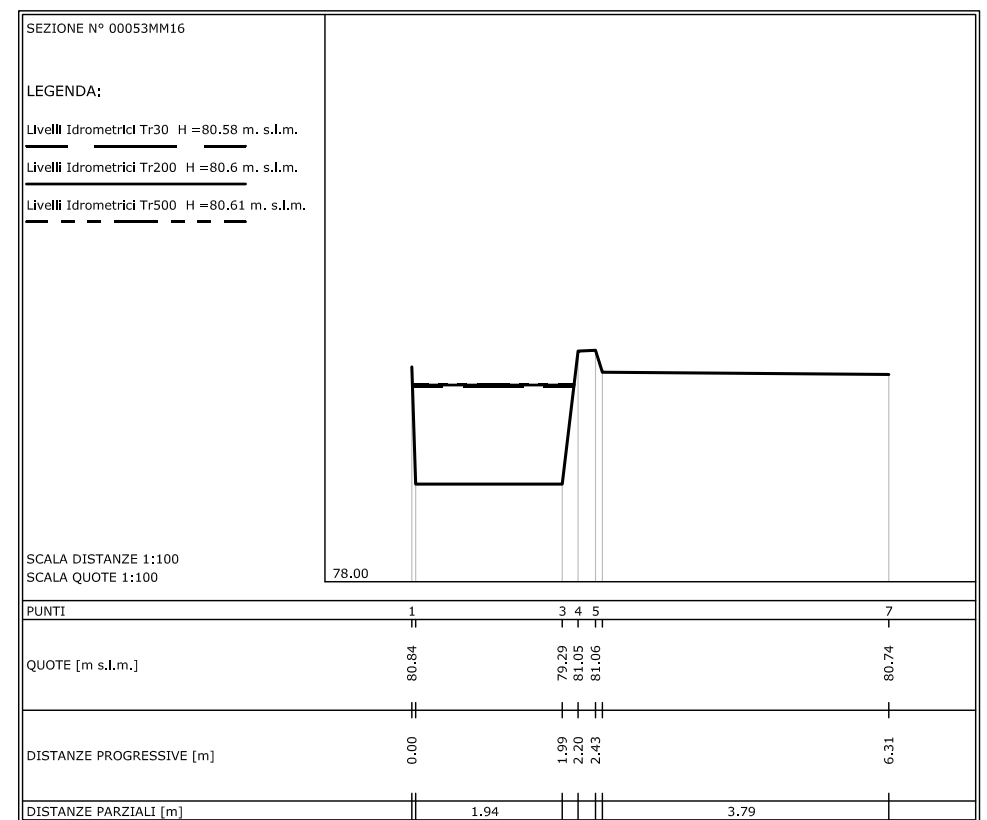
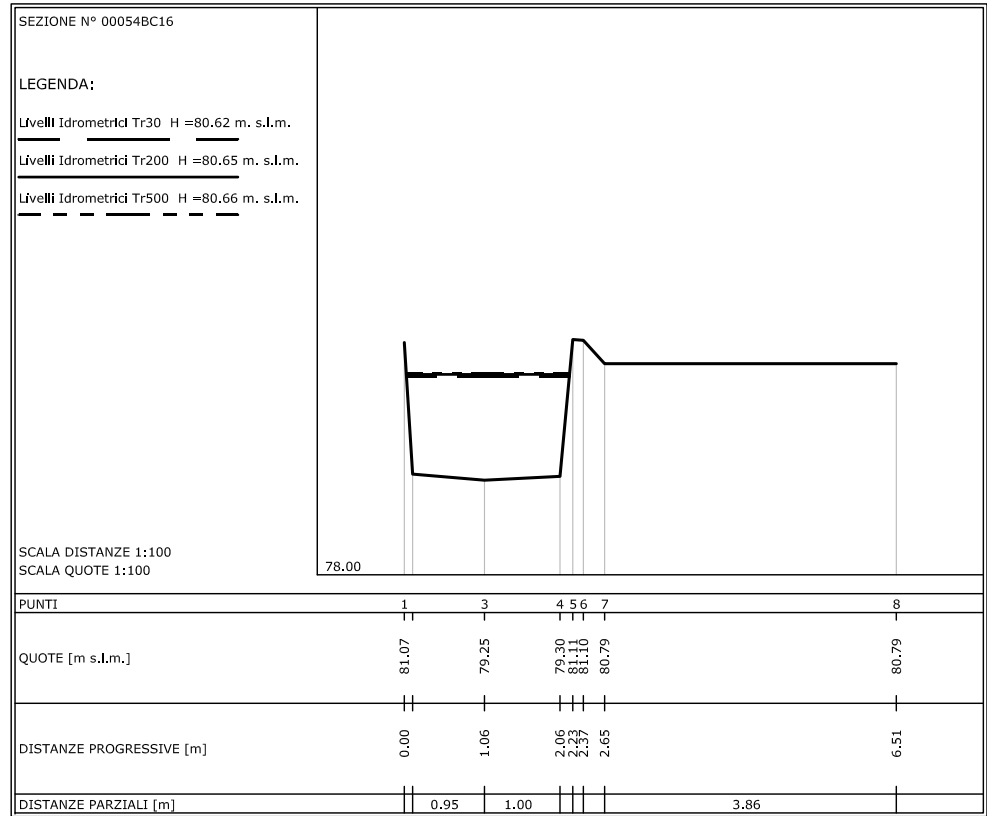

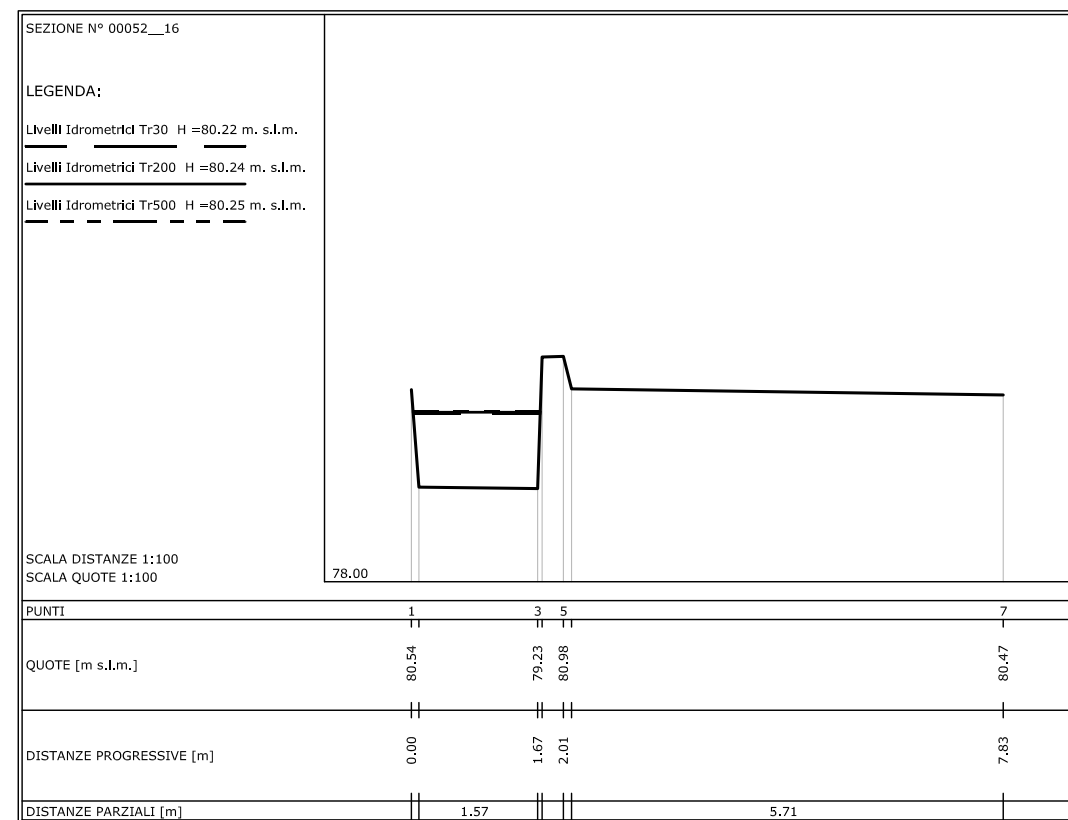
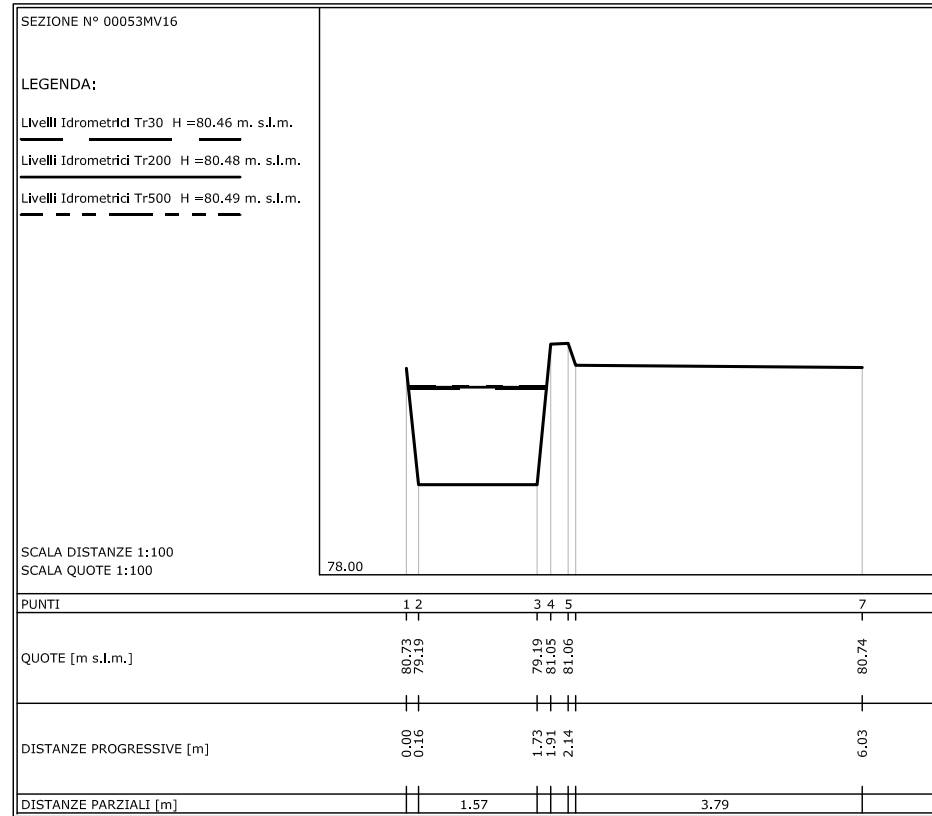

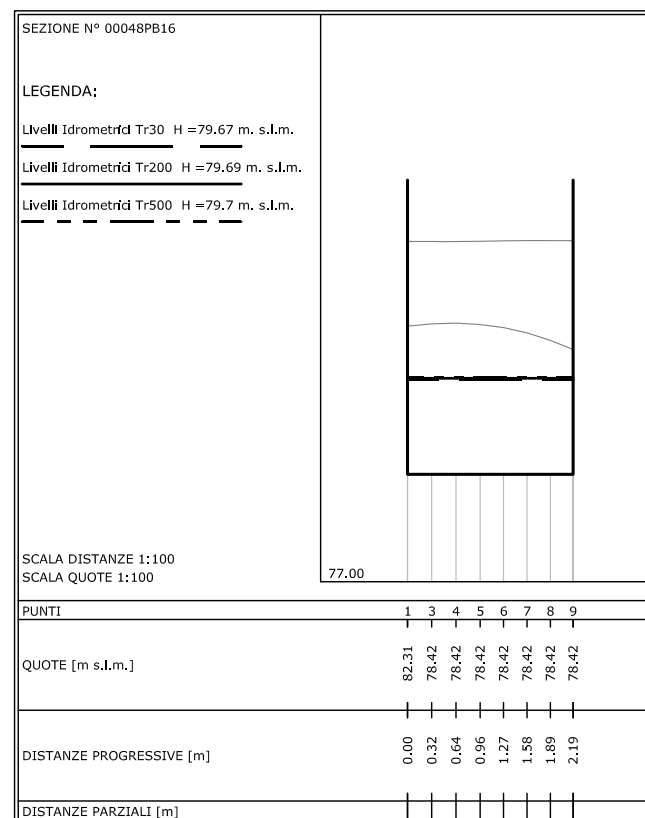
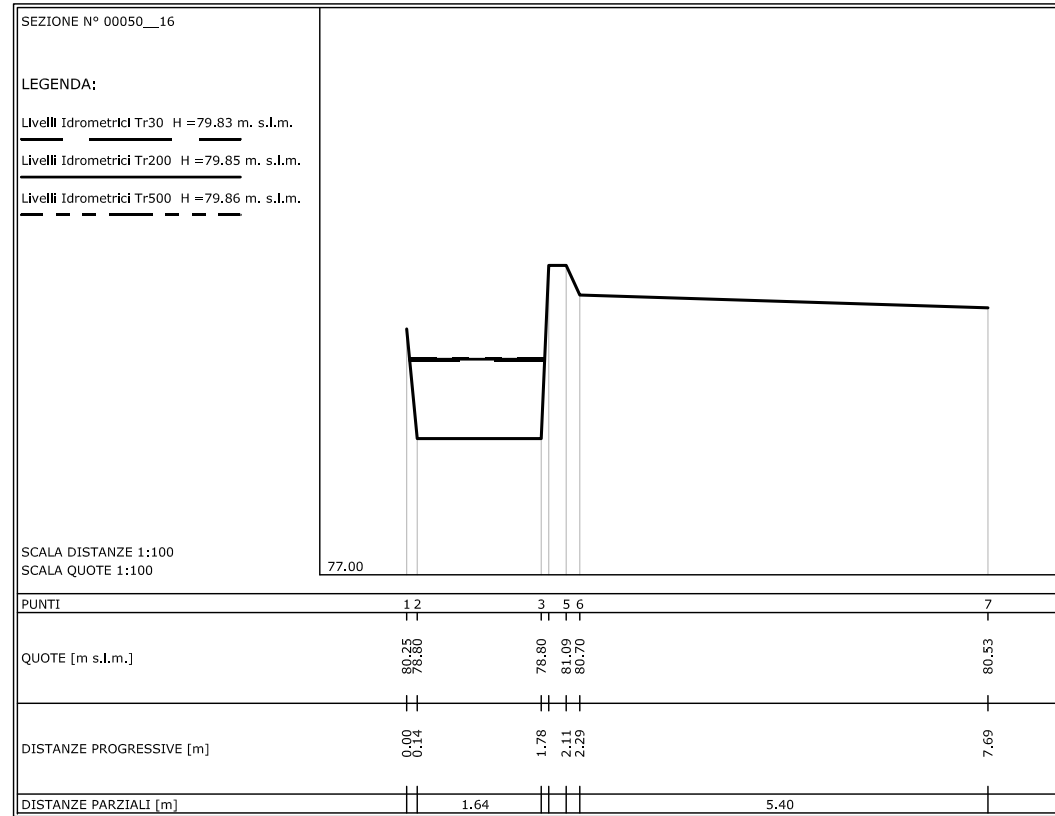

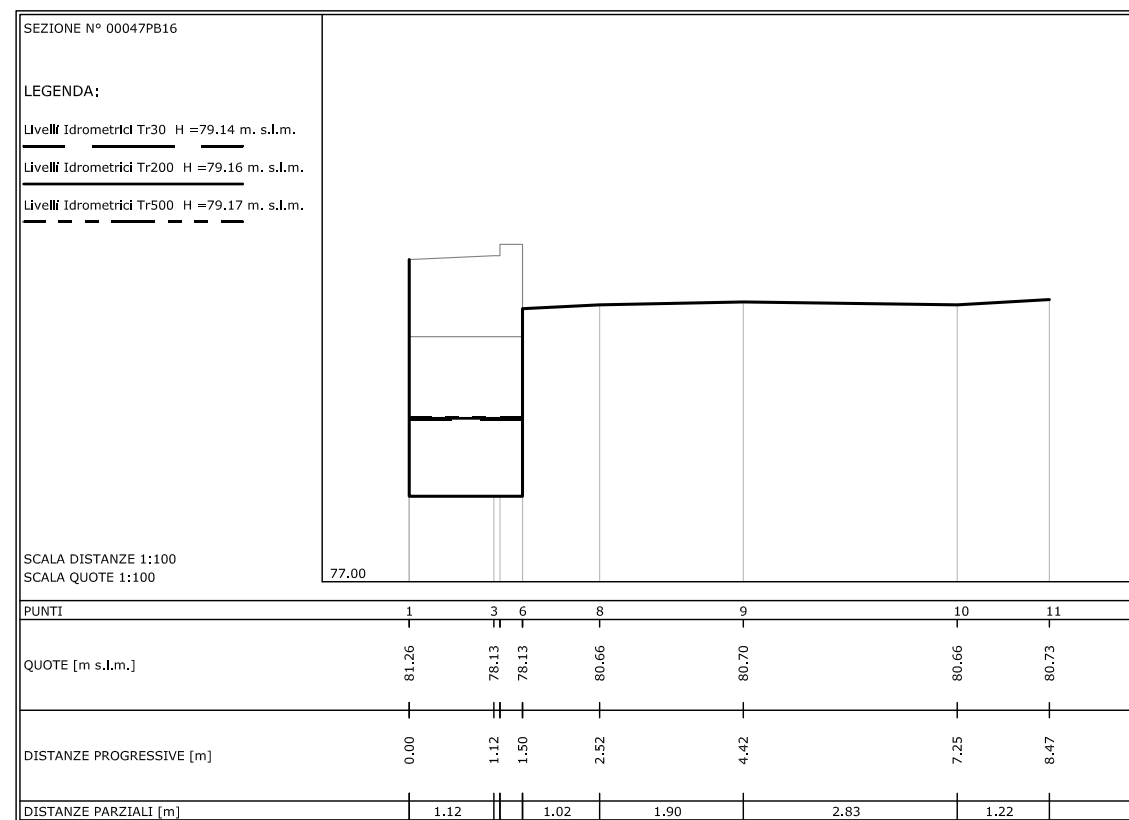
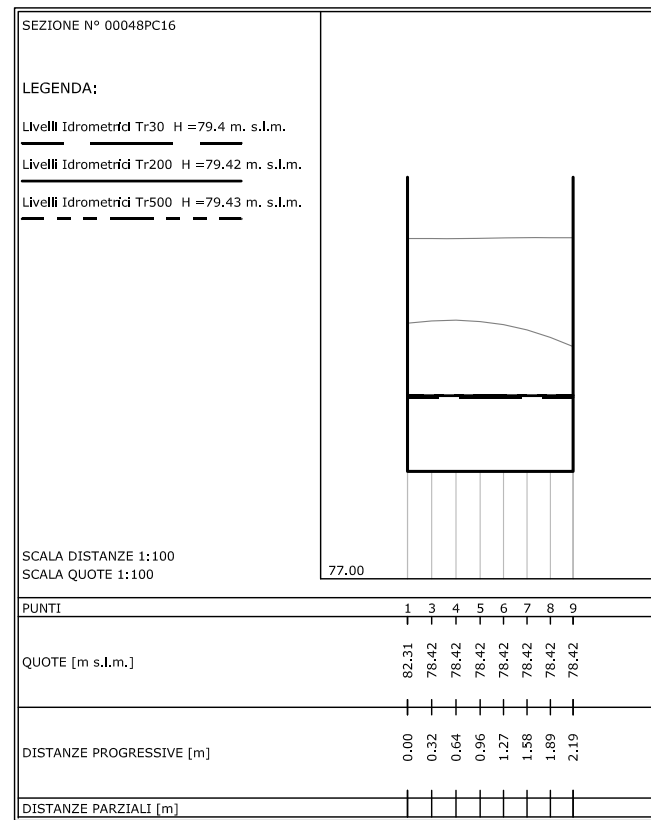



TAVOLA 5

Profilo Longitudinale con Livelli Idrometrici

Tr 30 – 200 – 500 Anni

Tavola 7
Planimetria dei Battenti Idraulici - Inviluppo Tr 200 anni
Scala 1:1500

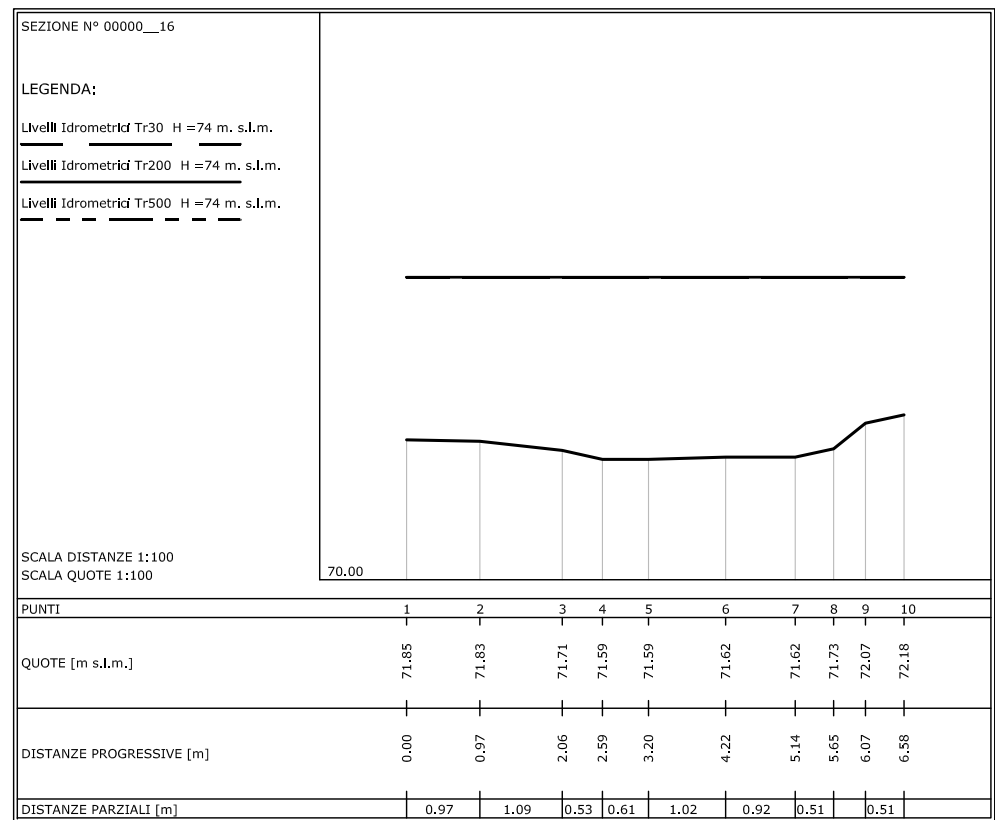
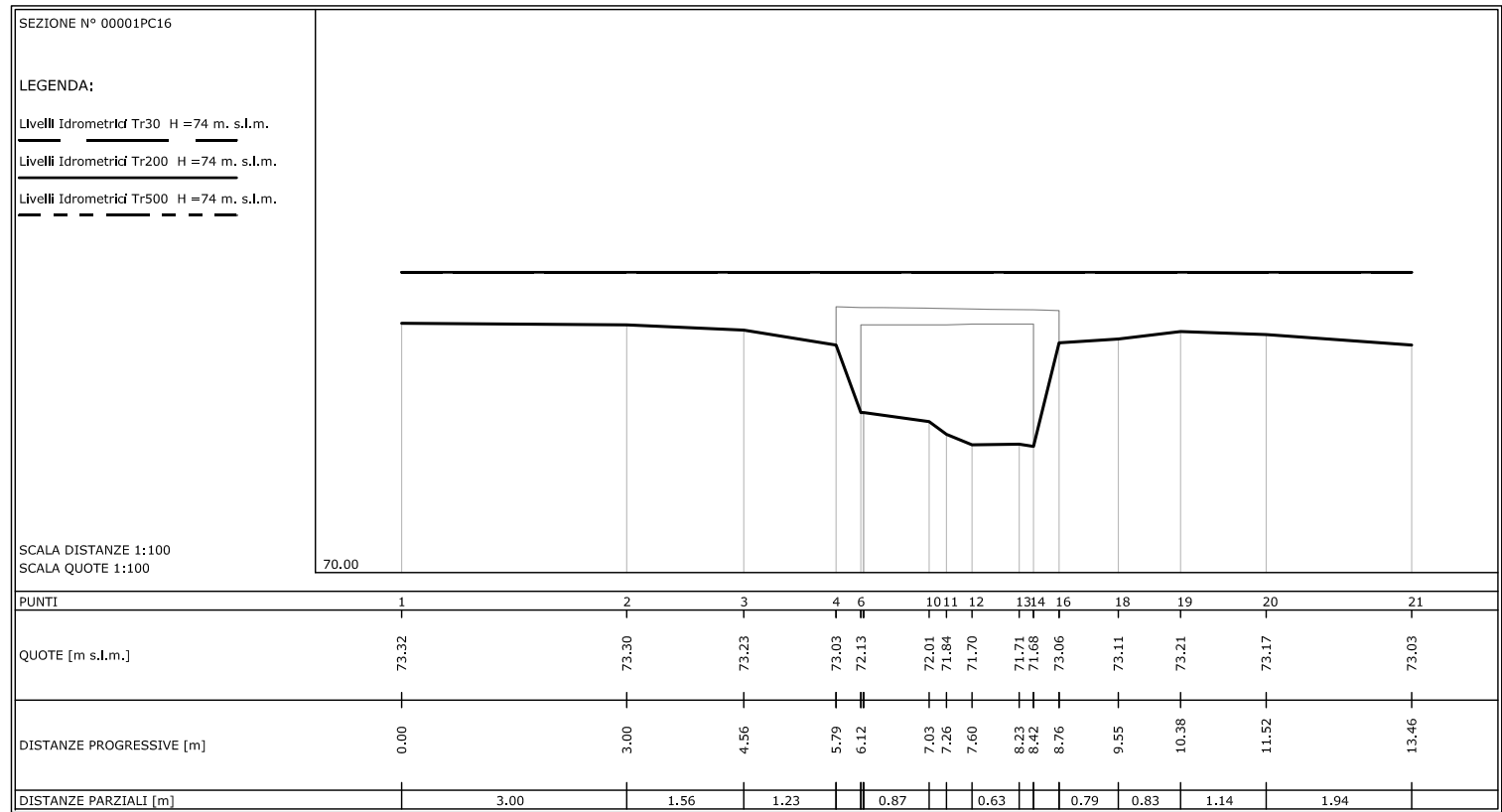
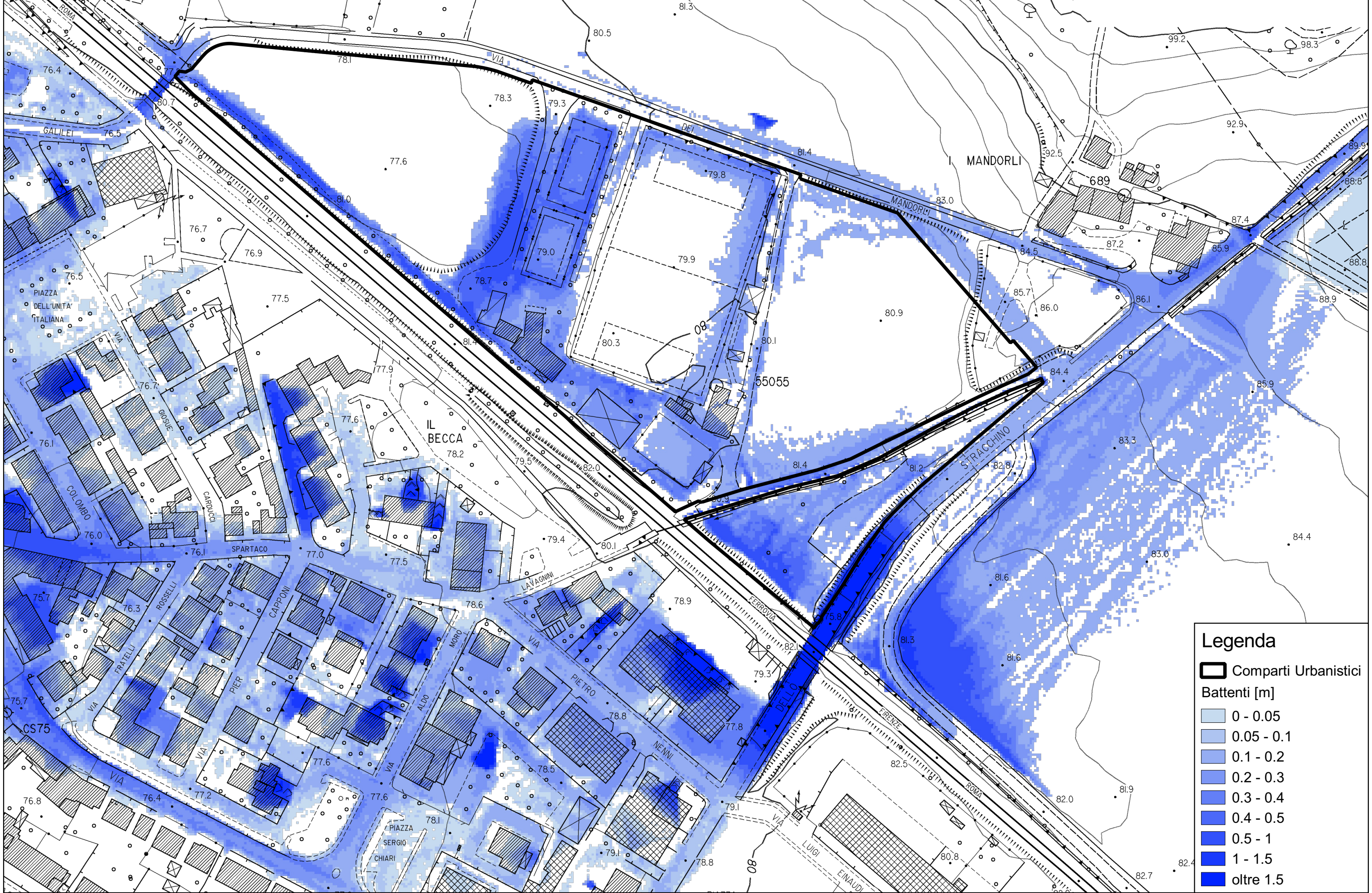

Tavola 10
Planimetria della Pericolosità idraulica ai sensi del 53R
Scala 1:10000

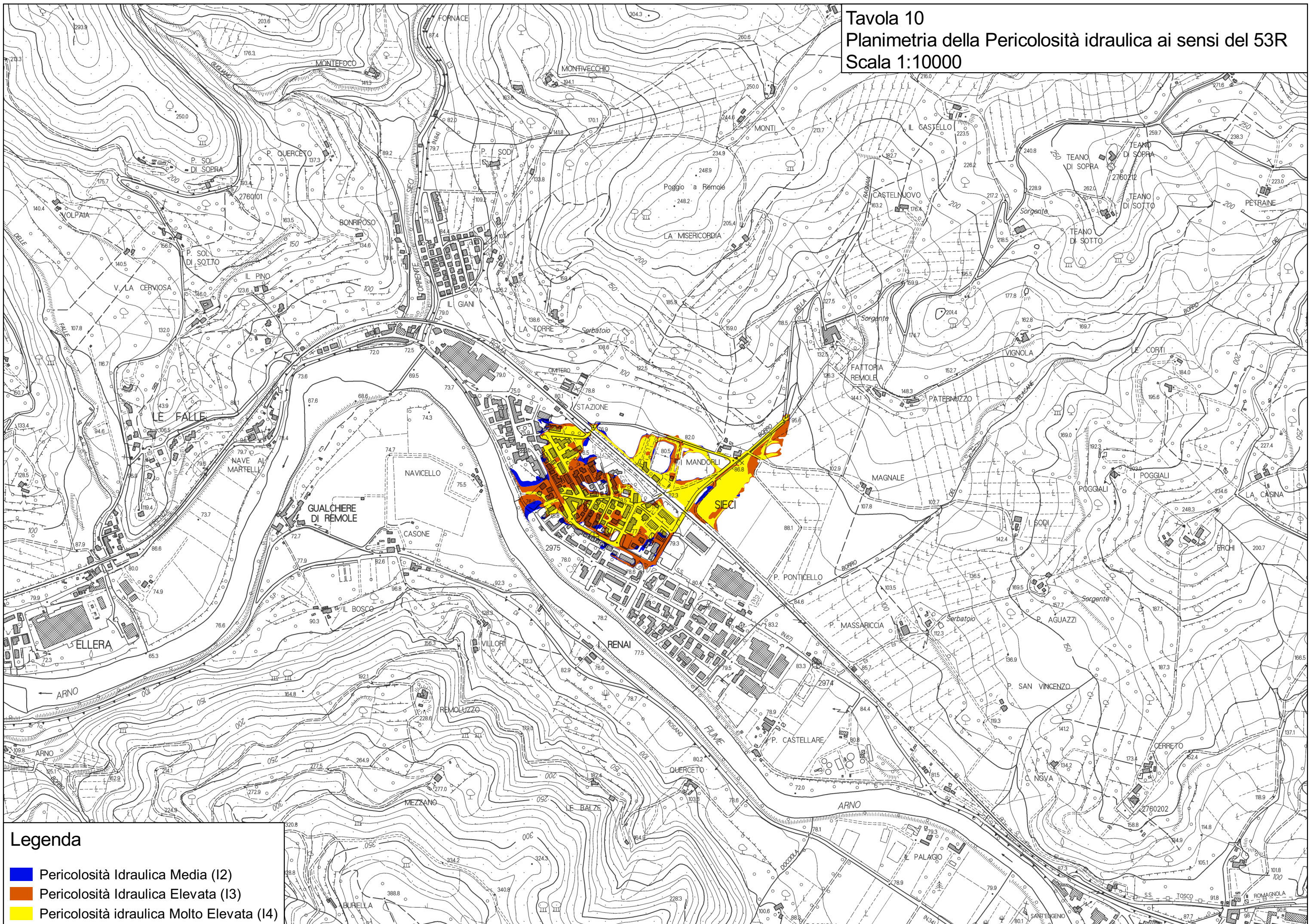

Legenda

- Pericolosità Idraulica Media (I2)
- Pericolosità Idraulica Elevata (I3)
- Pericolosità idraulica Molto Elevata (I4)